



PRICELIST 2025
OUTDOOR
30VAT

OUTDOOR KITCHENS

GEA	4
Pre-designed configurations	5
Marmolada T35 H60	6
Mamolada T35 H80	10
Brenta T28 H60	14
Brenta T28 H80	18
Latemar T20 H60	22
Latemar T20 H80	26
Sella T15 H40	30
Sella T15 H60	34
Sella T15 H80	38
Customized configurations	42
Units	45
Accessories	46
Extra Accessories	49
SWING	50
Customized configurations	51
Barbecue Units	52
Cook Unit	53
Big Green Egg Unit	54
Sink Units	55
Work Units	56
Refrigerator and Ice-Maker Units	57
Extra Accessories	58

BARBECUES

SWING BARBECUES	60
Free-Standing Barbecues	62
Barbecue Tops	63
GREEN BARBECUES	65
Free-Standing Barbecues	66
Barbecue Top	67
Extra Accessories	69

GEA kitchens



GEA pre-designed configurations



COLOUR



NF

FINISH



A

TOP



S



COLOUR



SA

FINISH



N

TOP



Q



COLOUR



NA

FINISH



A

TOP



L



COLOUR



SS

FINISH



N

TOP



Q



GEA Marmolada

T35 H60

dimensions



Aisi 316
The exterior of all modules and barbecues is made of Aisi 316 marine-grade stainless steel.

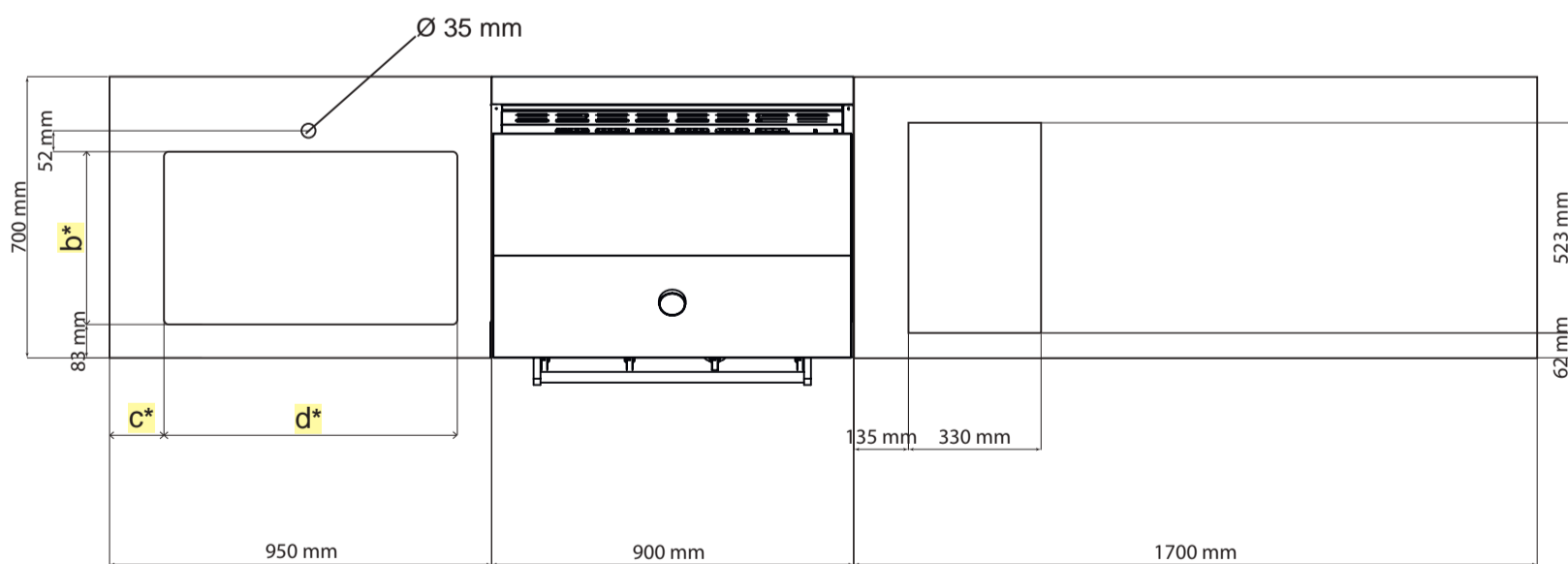
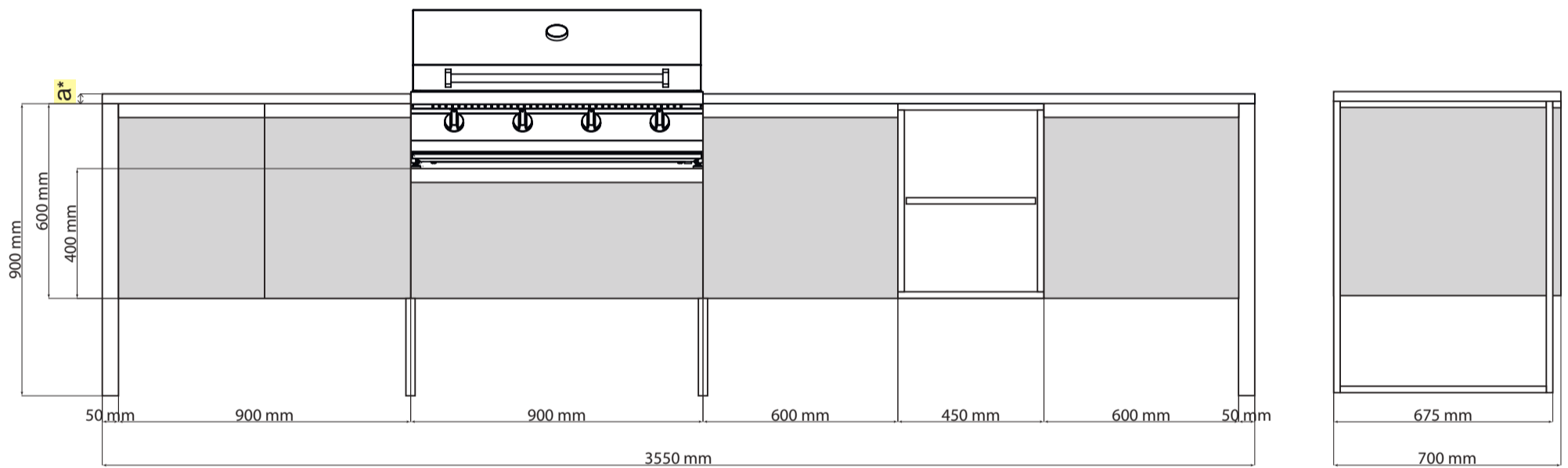

- *
 HPL top S. STEEL top
 • a = 12 mm • a = 30 mm
 • b = 730 mm • b = 700 mm
 • c = 135 mm • c = 150 mm
 • d = 430 mm • d = 400 mm

overall features and composition



BASE PRODUCTS

CODE	DESCRIPTION	Q.TY	PRICE/UNIT	PRICE TOTAL
T9S-6	Cabinet L=900 H=600 with doors	1	1215 €	6121 €
T9C-4	Cabinet L=900 H=400 with drawer	1	1420 €	
T6S-6 SX	Cabinet L=600 H=600 with door (left side opening)	1	1073 €	
T4G-6	Open cabinet L=450 H=600	1	868 €	
T6S-6 DX	Cabinet L=600 H=600 with door (right side opening)	1	1073 €	
TA-F6	Infill side panel	4	118 €	

DOOR/DRAWER COLOURS

CODE	COLOUR	DESCRIPTION	Q.TY	PRICE/UNIT	PRICE TOTAL
	 SS	Stainless steel	4	INCLUDED	-
ODC-CO NF	 NF	Nero Fumo	4	431 €	1724 €
ODC-CO SA	 SA	Sabbia	4	431 €	1724 €
ODC-CO NA	 NA	Nuvola	4	431 €	1724 €

HANDLE AND STRUCTURE FINISH

CODE	FINISH	DESCRIPTION	Q.TY	PRICE/UNIT	PRICE TOTAL
TA-TT9 N	 Nickel N	Frame structure, handles, support feet in nickel finish	2	444 €	1023 €
TA-KC6 N			1	135 €	
TA-TT9 A	 Nero A	Frame structure, handles, support feet in matt black finish	2	444 €	1023 €
TA-KC6 A			1	135 €	

COUNTERTOPS

CODE	TOP FINISH	DESCRIPTION	Q.TY	PRICE/UNIT	PRICE TOTAL
TA-TOP35L-L		HPL countertop - LAVAGNA	1	683 €	2622 €
TA-TOP35W-L			1	1037 €	
TA-L7		Built-in s.steel sink bowl 730x430	1	902 €	
TA-TOP35L-Q		HPL countertop - QUERCIA	1	683 €	2622 €
TA-TOP35W-Q			1	1037 €	
TA-L7		Built-in s.steel sink bowl 730x430	1	902 €	

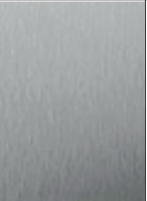
CODE	TOP FINISH	DESCRIPTION	Q.TY	PRICE/UNIT	PRICE TOTAL
TA-TOP35L-S		AISI 316 S. STEEL countertop and built-in s.steel sink bowl 700x400	1	4210 €	7383 €
TA-TOP35W-S			1	3173 €	









ACCESSORIES AND BARBECUE



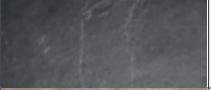

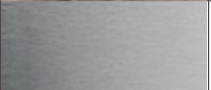

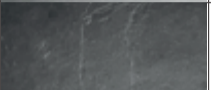

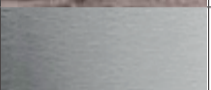
CODE	DESCRIPTION	Q.TY	PRICE/UNIT	PRICE TOTAL
MPC	Professional faucet with pull-out spray	1	649 €	7227 €
W4-1	Built-in rapid burner with knob	1	841 €	
T9-4G	Bbq top 25 kW. Insulated double-layer lid with thermometer	1	5502 €	
TA-B9	Filler shelf for bbq installation	1	151 €	
TA-T9104	Rear junction for bbq top	1	84 €	



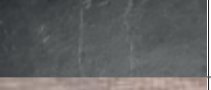

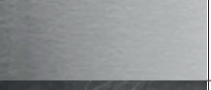

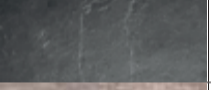

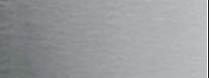
OPTIONAL KIT FOR ISLAND INSTALLATION





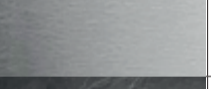

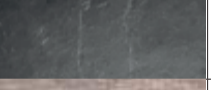

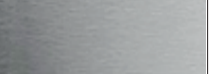
CODE	DESCRIPTION	Q.TY	PRICE/UNIT	PRICE TOTAL
TA-R6X6	Infill rear panel L=600 H=600	2	135 €	774 €
TA-R9X6	Infill rear panel L=900 H=600	2	151 €	
TA-R4X6	Infill rear panel L=450 H=600	1	118 €	
TA-T9129	Rear junction for bbq top	1	84 €	
TA-TOPIS35L-L	HPL countertop - LAVAGNA	1	1370 €	4533 €
TA-TOPIS35W-L		1	2261 €	
TA-L7	Built-in s.steel sink bowl 730x430		902 €	
TA-TOPIS35L-Q	HPL countertop - QUERCIA	1	1370 €	4533 €
TA-TOPIS35W-Q		1	2261 €	
TA-L7	Built-in s.steel sink bowl 730x430		902 €	
TA-TOPIS35L-S	AISI 316 S. STEEL countertop and built-in s.steel sink bowl 700x400	1	4889 €	9008 €
TA-TOPIS35W-S		1	4119 €	

overall prices

COLOUR		FINISH		TOP		CODE	PRICE
	SS		N		L	T35-60 SS-N-L	16993 €
					Q	T35-60 SS-N-Q	16993 €
					S	T35-60 SS-N-S	21754 €
			A		L	T35-60 SS-A-L	16993 €
					Q	T35-60 SS-A-Q	16993 €
					S	T35-60 SS-A-S	21754 €

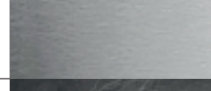
COLOUR		FINISH		TOP		CODE	PRICE
	NF		N		L	T35-60 NF-N-L	18717 €
					Q	T35-60 NF-N-Q	18717 €
					S	T35-60 NF-N-S	23478 €
			A		L	T35-60 NF-A-L	18717 €
					Q	T35-60 NF-A-Q	18717 €
					S	T35-60 NF-A-S	23478 €

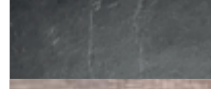
COLOUR		FINISH		TOP		CODE	PRICE
	SA		N		L	T35-60 SA-N-L	18717 €
					Q	T35-60 SA-N-Q	18717 €
					S	T35-60 SA-N-S	23478 €
			A		L	T35-60 SA-A-L	18717 €
					Q	T35-60 SA-A-Q	18717 €
					S	T35-60 SA-A-S	23478 €

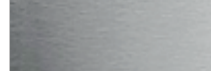
COLOUR		FINISH		TOP		CODE	PRICE
	NA		N		L	T35-60 NA-N-L	18717 €
					Q	T35-60 NA-N-Q	18717 €
					S	T35-60 NA-N-S	23478 €
			A		L	T35-60 NA-A-L	18717 €
					Q	T35-60 NA-A-Q	18717 €
					S	T35-60 NA-A-S	23478 €



GEA Marmolada

T35 H80

dimensions



Aisi 316

The exterior of all modules and barbecues is made of Aisi 316 marine-grade stainless steel.

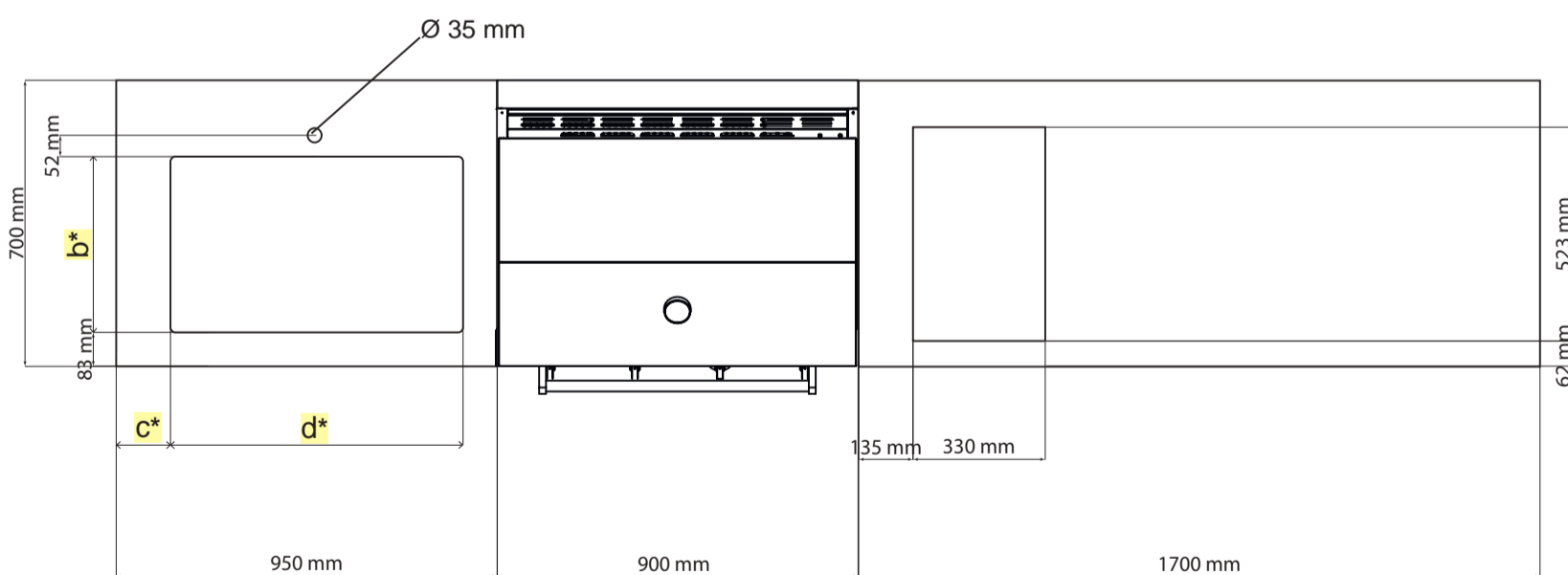
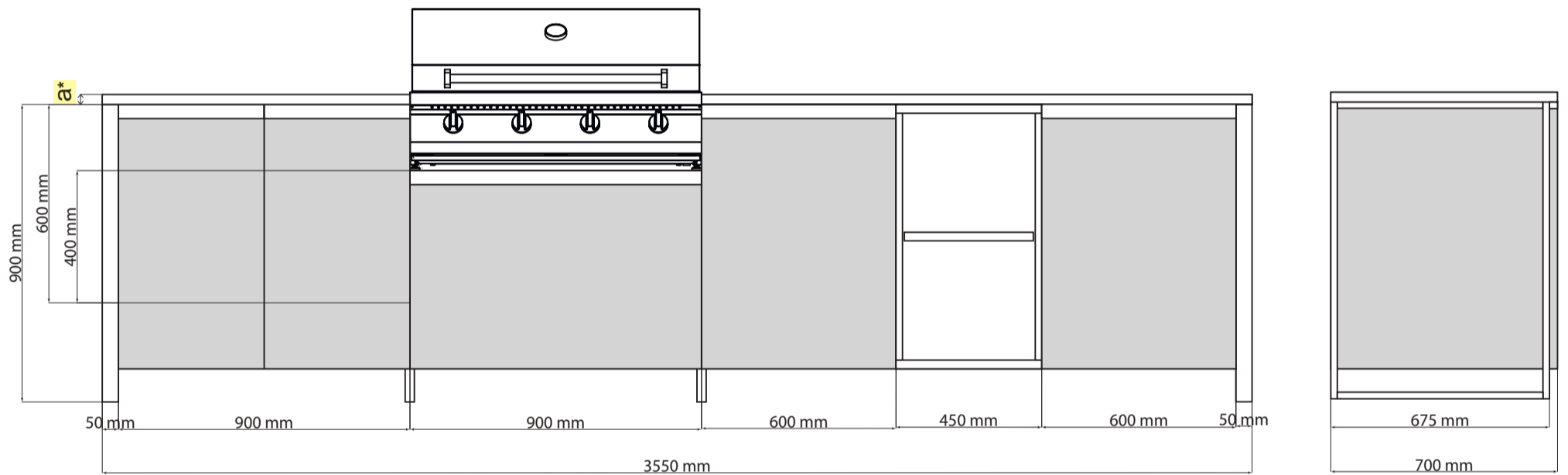

- *
 HPL top S.STEEL top
 • a = 12 mm • a = 30 mm
 • b = 730 mm • b = 700 mm
 • c = 135 mm • c = 150 mm
 • d = 430 mm • d = 400 mm

overall features and composition



BASE PRODUCTS

CODE	DESCRIPTION	Q.TY	PRICE/UNIT	PRICE TOTAL
T9S-8	Cabinet L=900 H=600 with doors	1	1420 €	6674 €
T9C-6	Cabinet L=900 H=400 with drawer	1	1491 €	
T6S-8 SX	Cabinet L=600 H=600 with door (left side opening)	1	1144 €	
T4G-8	Open cabinet L=450 H=600	1	935 €	
T6S-8 DX	Cabinet L=600 H=600 with door (right side opening)	1	1144 €	
TA-F8	Infill side panel	4	135 €	

DOOR/DRAWER COLOURS

CODE	COLOUR	DESCRIPTION	Q.TY	PRICE/UNIT	PRICE TOTAL
	 SS	Stainless steel	4	INCLUDED	-
ODC-CO NF	 NF	Nero Fumo	4	431 €	1724 €
ODC-CO SA	 SA	Sabbia	4	431 €	1724 €
ODC-CO NA	 NA	Nuvola	4	431 €	1724 €

HANDLES AND STRUCTURE FINISH

CODE	FINISH	DESCRIPTION	Q.TY	PRICE/UNIT	PRICE TOTAL
TA-TT9 N	 Nickel N	Frame structure, handles, support feet in nickel finish	2	444 €	1023 €
TA-KC8 N			1	135 €	
TA-TT9 A	 Nero A	Frame structure, handles, support feet in matt black finish	2	444 €	1023 €
TA-KC8 A			1	135 €	

COUNTERTOPS

CODE	TOP FINISH	DESCRIPTION	Q.TY	PRICE/UNIT	PRICE TOTAL
TA-TOP35L-L		HPL countertop - LAVAGNA	1	683 €	2622 €
TA-TOP35W-L			1	1037 €	
TA-L7		Built-in s.steel sink bowl 730x430	1	902 €	
TA-TOP35L-Q		HPL countertop - QUERCIA	1	683 €	2622 €
TA-TOP35W-Q			1	1037 €	
TA-L7		Built-in s.steel sink bowl 730x430	1	902 €	

CODE	TOP FINISH	DESCRIPTION	Q.TY	PRICE/UNIT	PRICE TOTAL
TA-TOP35L-S		AISI 316 S. STEEL countertop and built-in s.steel sink bowl 700x400	1	4210 €	7383 €
TA-TOP35W-S			1	3173 €	









ACCESSORIES AND BARBECUE

CODE	DESCRIPTION	Q.TY	PRICE/UNIT	PRICE TOTAL
MPC	Professional faucet with pull-out spray	1	649 €	7227 €
W4-1	Built-in rapid burner with knob	1	841 €	
T9-4G	Bbq top 25 kW. Insulated double-layer lid with thermometer	1	5502 €	
TA-B9	Filler shelf for bbq installation	1	151 €	
TA-T9104	Rear junction for bbq top	1	84 €	

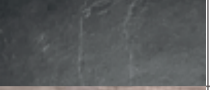

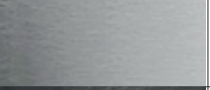

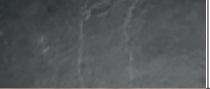

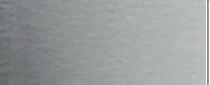

OPTIONAL KIT FOR ISLAND INSTALLATION





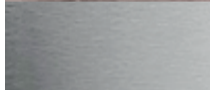

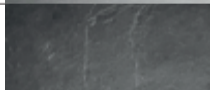

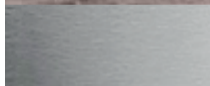
CODE	DESCRIPTION	Q.TY	PRICE/UNIT	PRICE TOTAL
TA-R6X8	Infill rear panel L=600 H=800	2	151 €	891 €
TA-R9X8	Infill rear panel L=900 H=800	2	185 €	
TA-R4X8	Infill rear panel L=450 H=800	1	135 €	
TA-T9129	Rear junction for bbq top	1	84 €	
TA-TOPIS35L-L	HPL countertop - LAVAGNA	1	1370 €	4533 €
TA-TOPIS35W-L		1	2261 €	
TA-L7	Built-in s.steel sink bowl 730x430	1	902 €	9008 €
TA-TOPIS35L-Q	HPL countertop - QUERCIA	1	1370 €	
TA-TOPIS35W-Q		1	2261 €	
TA-L7	Built-in s.steel sink bowl 730x430	1	902 €	
TA-TOPIS35L-S	AISI 316 S. STEEL countertop and built-in s.steel sink bowl 700x400	1	4889 €	9008 €
TA-TOPIS35W-S		1	4119 €	

overall prices

COLOUR		FINISH		TOP		CODE	PRICE
	SS		N		L	T35-80 SS-N-L	17546 €
					Q	T35-80 SS-N-Q	17546 €
					S	T35-80 SS-N-S	22307 €
			A		L	T35-80 SS-A-L	17546 €
					Q	T35-80 SS-A-Q	17546 €
					S	T35-80 SS-A-S	22307 €

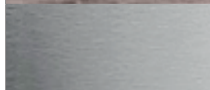
COLOUR		FINISH		TOP		CODE	PRICE
	NF		N		L	T35-80 NF-N-L	19270 €
					Q	T35-80 NF-N-Q	19270 €
					S	T35-80 NF-N-S	24031 €
			A		L	T35-80 NF-A-L	19270 €
					Q	T35-80 NF-A-Q	19270 €
					S	T35-80 NF-A-S	24031 €

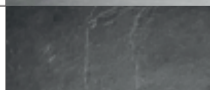
COLOUR		FINISH		TOP		CODE	PRICE
	SA		N		L	T35-80 SA-N-L	19270 €
					Q	T35-80 SA-N-Q	19270 €
					S	T35-80 SA-N-S	24031 €
			A		L	T35-80 SA-A-L	19270 €
					Q	T35-80 SA-A-Q	19270 €
					S	T35-80 SA-A-S	24031 €

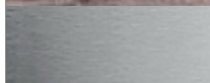
COLOUR		FINISH		TOP		CODE	PRICE
	NA		N		L	T35-80 NA-N-L	19270 €
					Q	T35-80 NA-N-Q	19270 €
					S	T35-80 NA-N-S	24031 €
			A		L	T35-80 NA-A-L	19270 €
					Q	T35-80 NA-A-Q	19270 €
					S	T35-80 NA-A-S	24031 €



dimensions



Aisi 316

The exterior of all modules and barbecues is made of Aisi 316 marine-grade stainless steel.

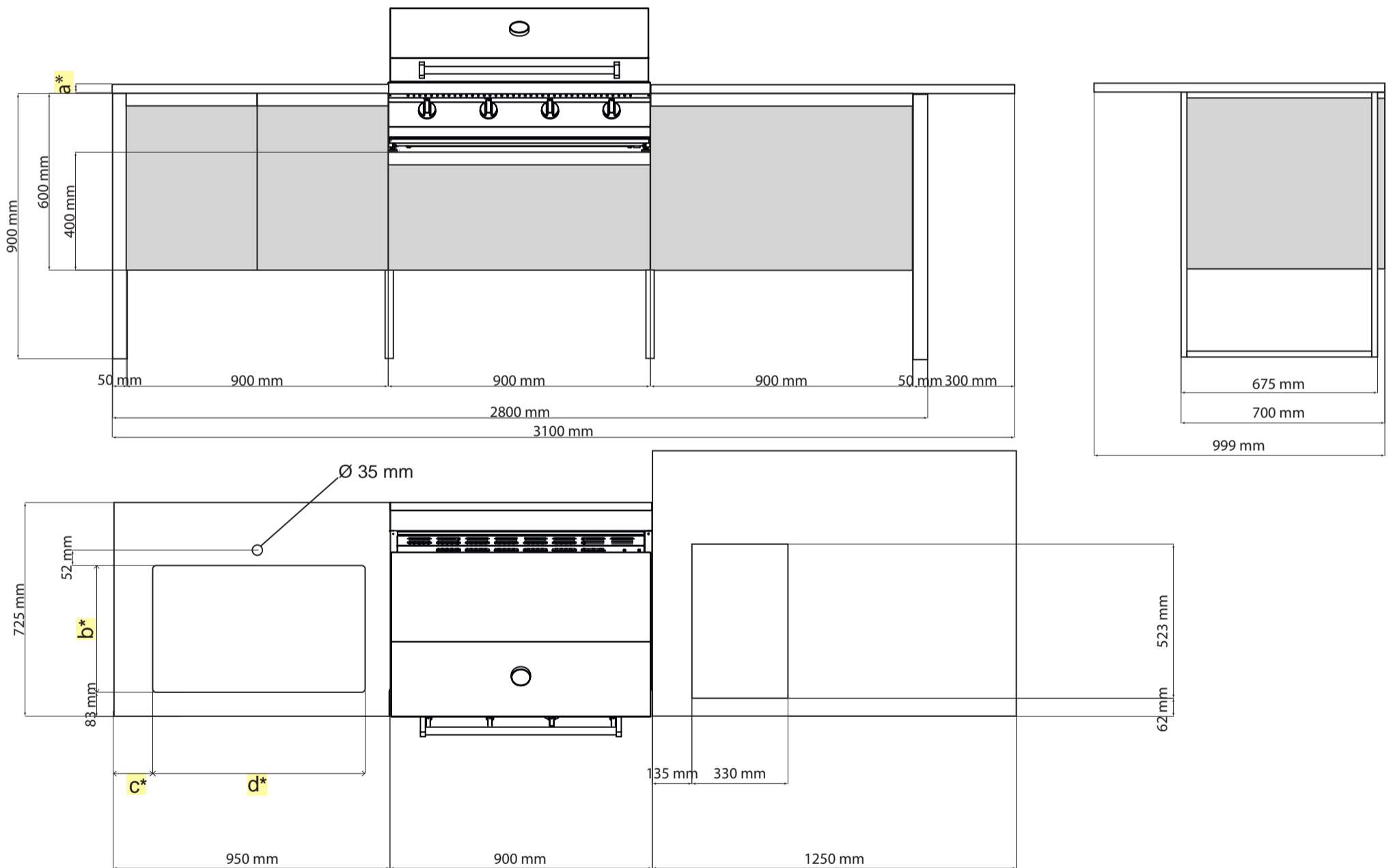

- *
 HPL top S.STEEL top
 • a = 12 mm • a = 30 mm
 • b = 730 mm • b = 700 mm
 • c = 135 mm • c = 150 mm
 • d = 430 mm • d = 400 mm

overall features and composition



BASE PRODUCTS

CODE	DESCRIPTION	Q.TY	PRICE/UNIT	PRICE TOTAL
T9S-6	Cabinet L=900 H=600 with doors	1	1215 €	5051 €
T9C-4	Cabinet L=900 H=400 with drawer	1	1420 €	
T9C-6	Cabinet L=600 H=600 with drawer	1	1491 €	
TA-F6	Infill side panel	4	118 €	
TA-R9X6	Infill rear panel L=900 H=600	3	151 €	



DOOR/DRAWER COLOURS

CODE	COLOUR	DESCRIPTION	Q.TY	PRICE/UNIT	PRICE TOTAL
	 SS	Stainless steel	3	INCLUDED	-
ODC-CO NF	 NF	Nero Fumo	3	431 €	1293 €
ODC-CO SA	 SA	Sabbia	3	431 €	1293 €
ODC-CO NA	 NA	Nuvola	3	431 €	1293 €

HANDLES AND STRUCTURE FINISH

CODE	FINISH	DESCRIPTION	Q.TY	PRICE/UNIT	PRICE TOTAL
TA-TT9 N	 Nickel N	Frame structure, handles, support feet in nickel finish	2	444 €	1023 €
TA-KC6 N			1	135 €	
TA-TT9 A	 Nero A	Frame structure, handles, support feet in matt black finish	2	444 €	1023 €
TA-KC6 A			1	135 €	

COUNTERTOPS









CODE	TOP FINISH	DESCRIPTION	Q.TY	PRICE/UNIT	PRICE TOTAL
TA-TOPIS28L-L		HPL countertop - LAVAGNA	1	1370 €	3332 €
TA-TOPIS28W-L			1	1060 €	
TA-L7		Built-in s.steel sink bowl 730x430	1	902 €	
TA-TOPIS28L-Q		HPL countertop - QUERCIA	1	1370 €	3332 €
TA-TOPIS28W-Q			1	1060 €	
TA-L7		Built-in s.steel sink bowl 730x430	1	902 €	





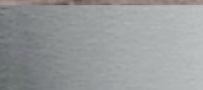

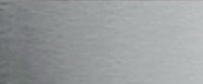

CODE	TOP FINISH	DESCRIPTION	Q.TY	PRICE/UNIT	PRICE TOTAL
TA-TOPIS28L-S		AISI 316 S. STEEL countertop and built-in s.steel sink bowl 700x400	1	4889 €	8853 €
TA-TOPIS28W-S			1	3964 €	



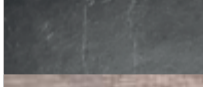

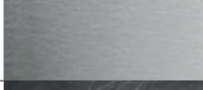

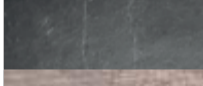

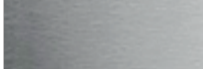
ACCESSORIES AND BARBECUE





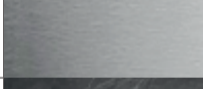

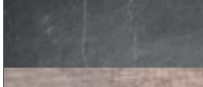

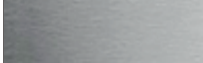
CODE	DESCRIPTION	Q.TY	PRICE/UNIT	PRICE TOTAL
MPC	Professional faucet with pull-out spray	1	649 €	7227 €
W4-1	Built-in rapid burner with knob	1	841 €	
T9-4G	Bbq top 25 kW. Insulated double-layer lid with thermometer	1	5502 €	
TA-B9	Filler shelf for bbq installation	1	151 €	
TA-T9129	Rear junction for bbq top	1	84 €	

overall prices

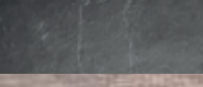
COLOUR		FINISH		TOP		CODE	PRICE
	SS		N		L	T28-60 SS-N-L	16633 €
					Q	T28-60 SS-N-Q	16633 €
					S	T28-60 SS-N-S	22154 €
			A		L	T28-60 SS-A-L	16633 €
					Q	T28-60 SS-A-Q	16633 €
					S	T28-60 SS-A-S	22154 €

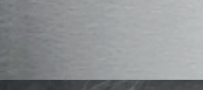
COLOUR		FINISH		TOP		CODE	PRICE
	NF		N		L	T28-60 NF-N-L	17926 €
					Q	T28-60 NF-N-Q	17926 €
					S	T28-60 NF-N-S	23447 €
			A		L	T28-60 NF-A-L	17926 €
					Q	T28-60 NF-A-Q	17926 €
					S	T28-60 NF-A-S	23447 €

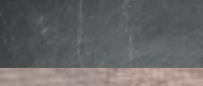
COLOUR		FINISH		TOP		CODE	PRICE
	SA		N		L	T28-60 SA-N-L	17926 €
					Q	T28-60 SA-N-Q	17926 €
					S	T28-60 SA-N-S	23447 €
			A		L	T28-60 SA-A-L	17926 €
					Q	T28-60 SA-A-Q	17926 €
					S	T28-60 SA-A-S	23447 €

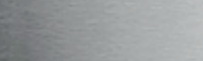
COLOUR		FINISH		TOP		CODE	PRICE
	NA		N		L	T28-60 NA-N-L	17926 €
					Q	T28-60 NA-N-Q	17926 €
					S	T28-60 NA-N-S	23447 €
			A		L	T28-60 NA-A-L	17926 €
					Q	T28-60 NA-A-Q	17926 €
					S	T28-60 NA-A-S	23447 €



dimensions



Aisi 316

The exterior of all modules and barbecues is made of Aisi 316 marine-grade stainless steel.

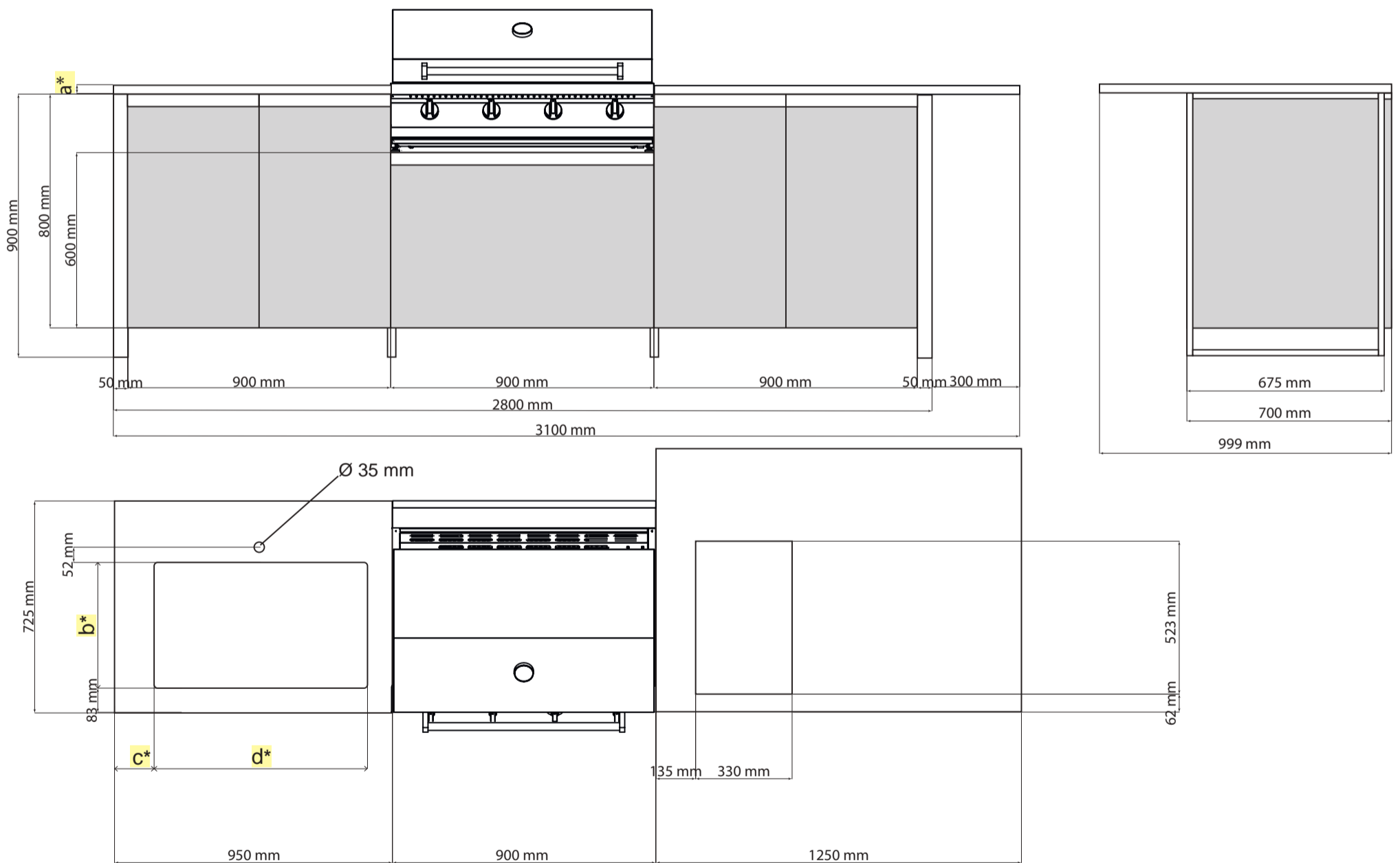

- *
 HPL top S.STEEL top
 • a = 12 mm • a = 30 mm
 • b = 730 mm • b = 700 mm
 • c = 135 mm • c = 150 mm
 • d = 430 mm • d = 400 mm

overall features and composition



BASE PRODUCTS

CODE	DESCRIPTION	Q.TY	PRICE/UNIT	PRICE TOTAL
T9S-8	Cabinet L=900 H=600 with doors	2	1420 €	5426 €
T9C-6	Cabinet L=900 H=400 with drawer	1	1491 €	
TA-F8	Infill side panel	4	135 €	
TA-R9X8	Infill rear panel L=900 H=600	3	185 €	

DOOR/DRAWER COLOURS

CODE	COLOUR	DESCRIPTION	Q.TY	PRICE/UNIT	PRICE TOTAL
	 SS	Stainless steel	3	INCLUDED	-
ODC-CO NF	 NF	Nero Fumo	3	431 €	1293 €
ODC-CO SA	 SA	Sabbia	3	431 €	1293 €
ODC-CO NA	 NA	Nuvola	3	431 €	1293 €

HANDLES AND STRUCTURE FINISH

CODE	FINISH	DESCRIPTION	Q.TY	PRICE/UNIT	PRICE TOTAL
TA-TT9 N	 Nickel N	Frame structure, handles, support feet in nickel finish	2	444 €	1023 €
TA-KC8 N			1	135 €	
TA-TT9 A	 Nero A	Frame structure, handles, support feet in matt black finish	2	444 €	1023 €
TA-KC8 A			1	135 €	

COUNTERTOPS

CODE	TOP FINISH	DESCRIPTION	Q.TY	PRICE/UNIT	PRICE TOTAL
TA-TOPIS28L-L		HPL countertop - LAVAGNA	1	1370 €	3332 €
TA-TOPIS28W-L			1	1060 €	
TA-L7		Built-in s.steel sink bowl 730x430	1	902 €	
TA-TOPIS28L-Q		HPL countertop - QUERCIA	1	1370 €	3332 €
TA-TOPIS28W-Q			1	1060 €	
TA-L7		Built-in s.steel sink bowl 730x430	1	902 €	

CODE	TOP FINISH	DESCRIPTION	Q.TY	PRICE/UNIT	PRICE TOTAL
TA-TOPIS28L-S		AISI 316 S. STEEL countertop and built-in s.steel sink bowl 700x400	1	4889 €	8853 €
TA-TOPIS28W-S			1	3964 €	









ACCESSORIES AND BARBECUE





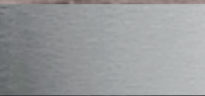

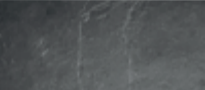

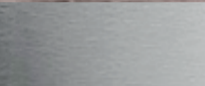
CODE	DESCRIPTION	Q.TY	PRICE/UNIT	PRICE TOTAL
MPC	Professional faucet with pull-out spray	1	649 €	7227 €
W4-1	Built-in rapid burner with knob	1	841 €	
T9-4G	Bbq top 25 kW. Insulated double-layer lid with thermometer	1	5502 €	
TA-B9	Filler shelf for bbq installation	1	151 €	
TA-T9129	Rear junction for bbq top	1	84 €	



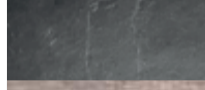

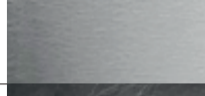

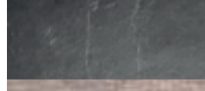

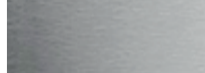
GEA Brenta



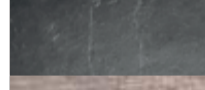

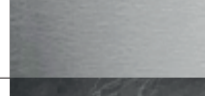

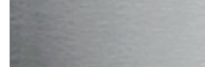

overall prices

T28 H80

COLOUR		FINISH		TOP		CODE	PRICE
	SS		N		L	T28-80 SS-N-L	17008 €
					Q	T28-80 SS-N-Q	17008 €
					S	T28-80 SS-N-S	22529 €
			A		L	T28-80 SS-A-L	17008 €
					Q	T28-80 SS-A-Q	17008 €
					S	T28-80 SS-A-S	22529 €

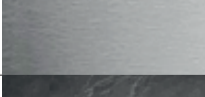
COLOUR		FINISH		TOP		CODE	PRICE
	NF		N		L	T28-80 NF-N-L	18301 €
					Q	T28-80 NF-N-Q	18301 €
					S	T28-80 NF-N-S	23822 €
			A		L	T28-80 NF-A-L	18301 €
					Q	T28-80 NF-A-Q	18301 €
					S	T28-80 NF-A-S	23822 €

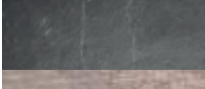
COLOUR		FINISH		TOP		CODE	PRICE
	SA		N		L	T28-80 SA-N-L	18301 €
					Q	T28-80 SA-N-Q	18301 €
					S	T28-80 SA-N-S	23822 €
			A		L	T28-80 SA-A-L	18301 €
					Q	T28-80 SA-A-Q	18301 €
					S	T28-80 SA-A-S	23822 €

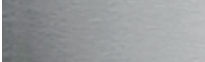
COLOUR		FINISH		TOP		CODE	PRICE
	NA		N		L	T28-80 NA-N-L	18301 €
					Q	T28-80 NA-N-Q	18301 €
					S	T28-80 NA-N-S	23822 €
			A		L	T28-80 NA-A-L	18301 €
					Q	T28-80 NA-A-Q	18301 €
					S	T28-80 NA-A-S	23822 €



dimensions



Aisi 316

The exterior of all modules and barbecues is made of Aisi 316 marine-grade stainless steel.

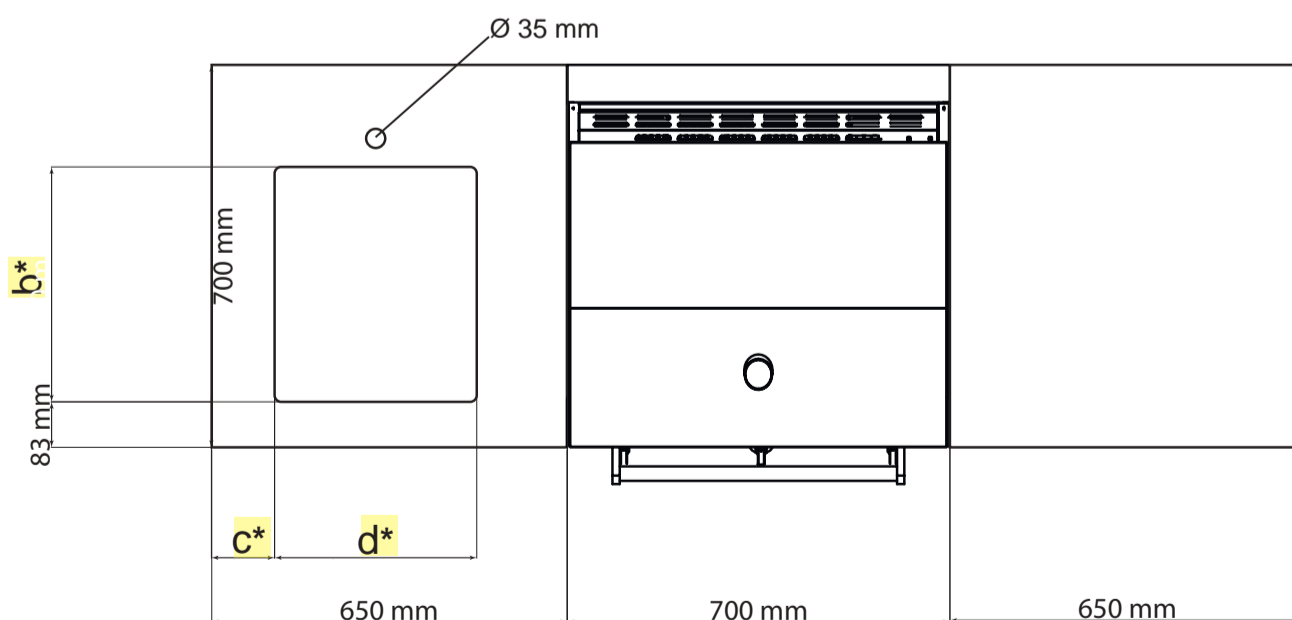
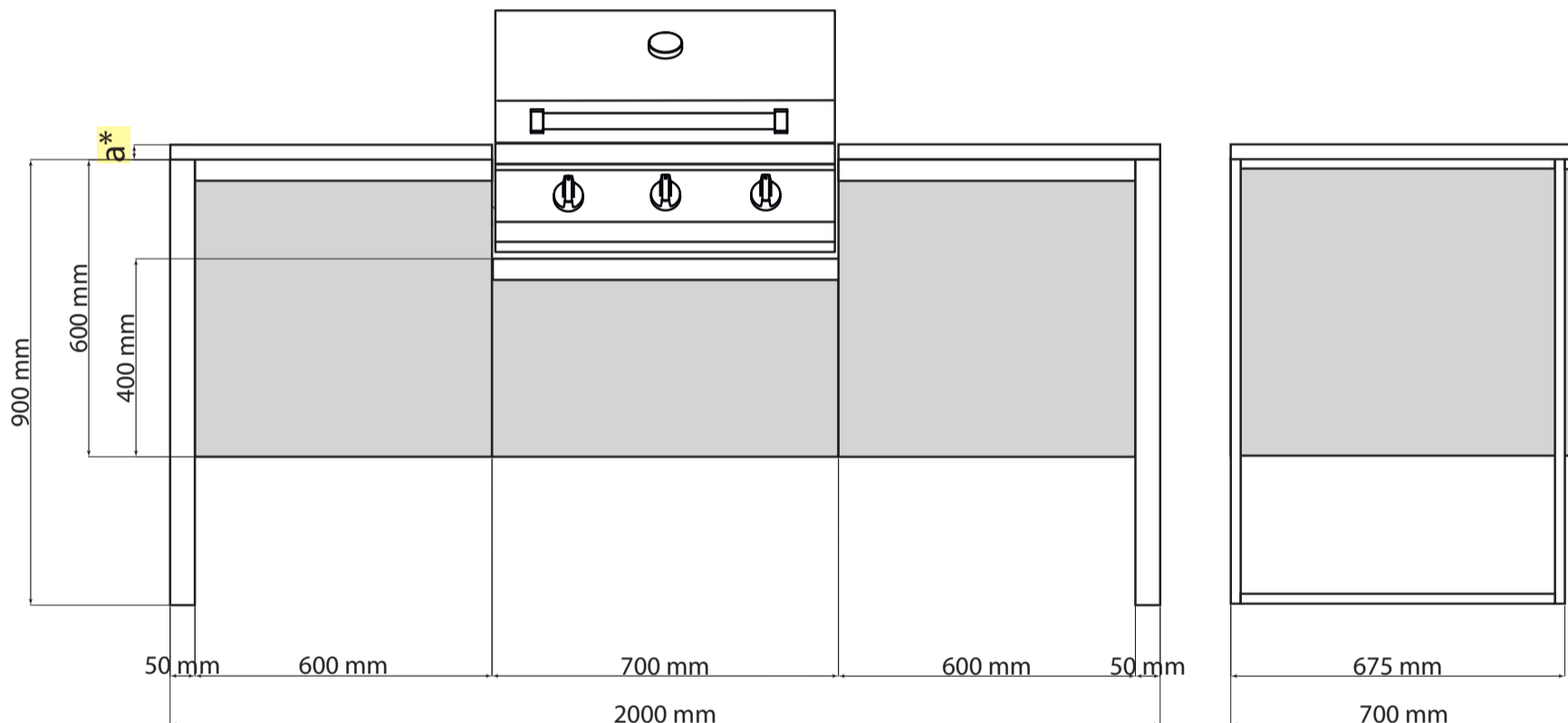

- *
 HPL top S.STEEL top
 • a = 12 mm • a = 30 mm
 • b = 370 mm • b = 400 mm
 • c = 135 mm • c = 150 mm
 • d = 430 mm • d = 400 mm

overall features and composition



BASE PRODUCTS

CODE	DESCRIPTION	Q.TY	PRICE/UNIT	PRICE TOTAL
T6S-6 SX	Cabinet L=600 H=600 with door (left side opening)	1	1073 €	3833 €
T7C-4	Cabinet L=700 H=400 with drawer	1	1215 €	
T6S-6 DX	Cabinet L=600 H=600 with door (right side opening)	1	1073 €	
TA-F6	Infill side panel	4	118 €	

DOOR/DRAWER COLOURS

CODE	COLOUR	DESCRIPTION	Q.TY	PRICE/UNIT	PRICE TOTAL
	 SS	Stainless steel	3	INCLUDED	-
ODC-CO NF	 NF	Nero Fumo	3	431 €	1293 €
ODC-CO SA	 SA	Sabbia	3	431 €	1293 €
ODC-CO NA	 NA	Nuvola	3	431 €	1293 €

HANDLES AND STRUCTURE FINISH

CODE	FINISH	DESCRIPTION	Q.TY	PRICE/UNIT	PRICE TOTAL
TA-TT9 N	 Nickel N	Frame structure, handles, support feet in nickel finish	2	444 €	1023 €
TA-KC6 N			1	135 €	
TA-TT9 A	 Nero A	Frame structure, handles, support feet in matt black finish	2	444 €	1023 €
TA-KC6 A			1	135 €	

COUNTERTOPS

CODE	TOP FINISH	DESCRIPTION	Q.TY	PRICE/UNIT	PRICE TOTAL
TA-TOP20L-L		HPL countertop - LAVAGNA	1	529 €	1438 €
TA-TOP20-L			1	367 €	
TA-L4		Built-in s.steel sink bowl 370x430	1	542 €	
TA-TOP20L-Q		HPL countertop - QUERCIA	1	529 €	1438 €
TA-TOP20-Q			1	367 €	
TA-L4		Built-in s.steel sink bowl 370x430	1	542 €	

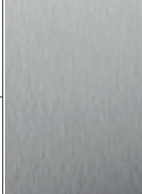
CODE	TOP FINISH	DESCRIPTION	Q.TY	PRICE/UNIT	PRICE TOTAL
TA-TOP20L-S		AISI 316 S. STEEL countertop and built-in s.steel sink bowl 400x400	1	2207 €	4374 €
TA-TOP20-S			1	2167 €	









ACCESSORIES AND BARBECUE



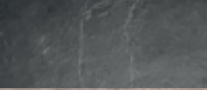

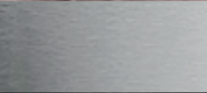

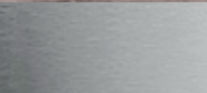

CODE	DESCRIPTION	Q.TY	PRICE/UNIT	PRICE TOTAL
MPC	Professional faucet with pull-out spray	1	649 €	5478 €
T7-3G	Bbq top 19 kW. Insulated double-layer lid with thermometer	1	4610 €	
TA-B7	Filler shelf for bbq installation	1	135 €	
TA-T7104	Rear junction for bbq top	1	84 €	





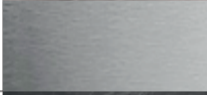

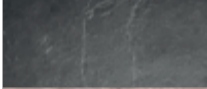

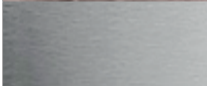
OPTIONAL KIT FOR ISLAND INSTALLATION





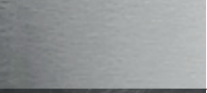

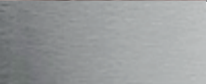

CODE	DESCRIPTION	Q.TY	PRICE/UNIT	PRICE TOTAL
TA-R6X6	Infill rear panel L=600 H=600	2	135 €	499 €
TA-R7X6	Infill rear panel L=700 H=600	1	145 €	
TA-T7129	Rear junction for bbq top	1	84 €	
TA-TOPIS20L-L	HPL countertop - LAVAGNA	1	996 €	2373 €
TA-TOPIS20-L		1	835 €	
TA-L4	Built-in s.steel sink bowl 370x430	1	542 €	
TA-TOPIS20L-Q	HPL countertop - QUERCIA	1	996 €	2373 €
TA-TOPIS20-Q		1	835 €	
TA-L4	Built-in s.steel sink bowl 370x430	1	542 €	
TA-TOPIS20L-S	AISI 316 S. STEEL countertop and built-in s.steel sink bowl 400x400	1	2779 €	5521 €
TA-TOPIS20-S		1	2742 €	

overall prices

COLOUR		FINISH		TOP		CODE	PRICE
	SS		N		L	T20-60 SS-N-L	11772 €
					Q	T20-60 SS-N-Q	11772 €
					S	T20-60 SS-N-S	14708 €
			A		L	T20-60 SS-A-L	11772 €
					Q	T20-60 SS-A-Q	11772 €
					S	T20-60 SS-A-S	14708 €

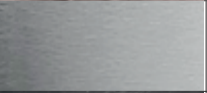
COLOUR		FINISH		TOP		CODE	PRICE
	NF		N		L	T20-60 NF-N-L	13065 €
					Q	T20-60 NF-N-Q	13065 €
					S	T20-60 NF-N-S	16001 €
			A		L	T20-60 NF-A-L	13065 €
					Q	T20-60 NF-A-Q	13065 €
					S	T20-60 NF-A-S	16001 €

COLOUR		FINISH		TOP		CODE	PRICE
	SA		N		L	T20-60 SA-N-L	13065 €
					Q	T20-60 SA-N-Q	13065 €
					S	T20-60 SA-N-S	16001 €
			A		L	T20-60 SA-A-L	13065 €
					Q	T20-60 SA-A-Q	13065 €
					S	T20-60 SA-A-S	16001 €

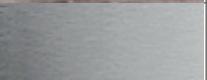
COLOUR		FINISH		TOP		CODE	PRICE
	NA		N		L	T20-60 NA-N-L	13065 €
					Q	T20-60 NA-N-Q	13065 €
					S	T20-60 NA-N-S	16001 €
			A		L	T20-60 NA-A-L	13065 €
					Q	T20-60 NA-A-Q	13065 €
					S	T20-60 NA-A-S	16001 €



dimensions



Aisi 316

The exterior of all modules and barbecues is made of Aisi 316 marine-grade stainless steel.

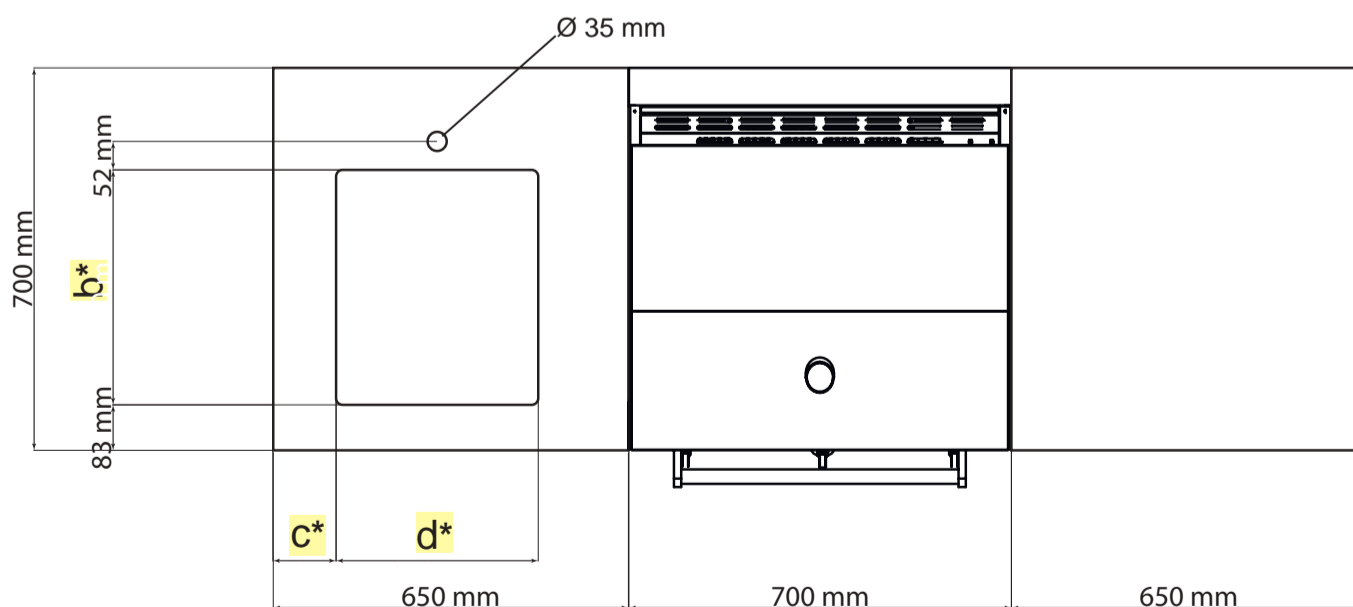
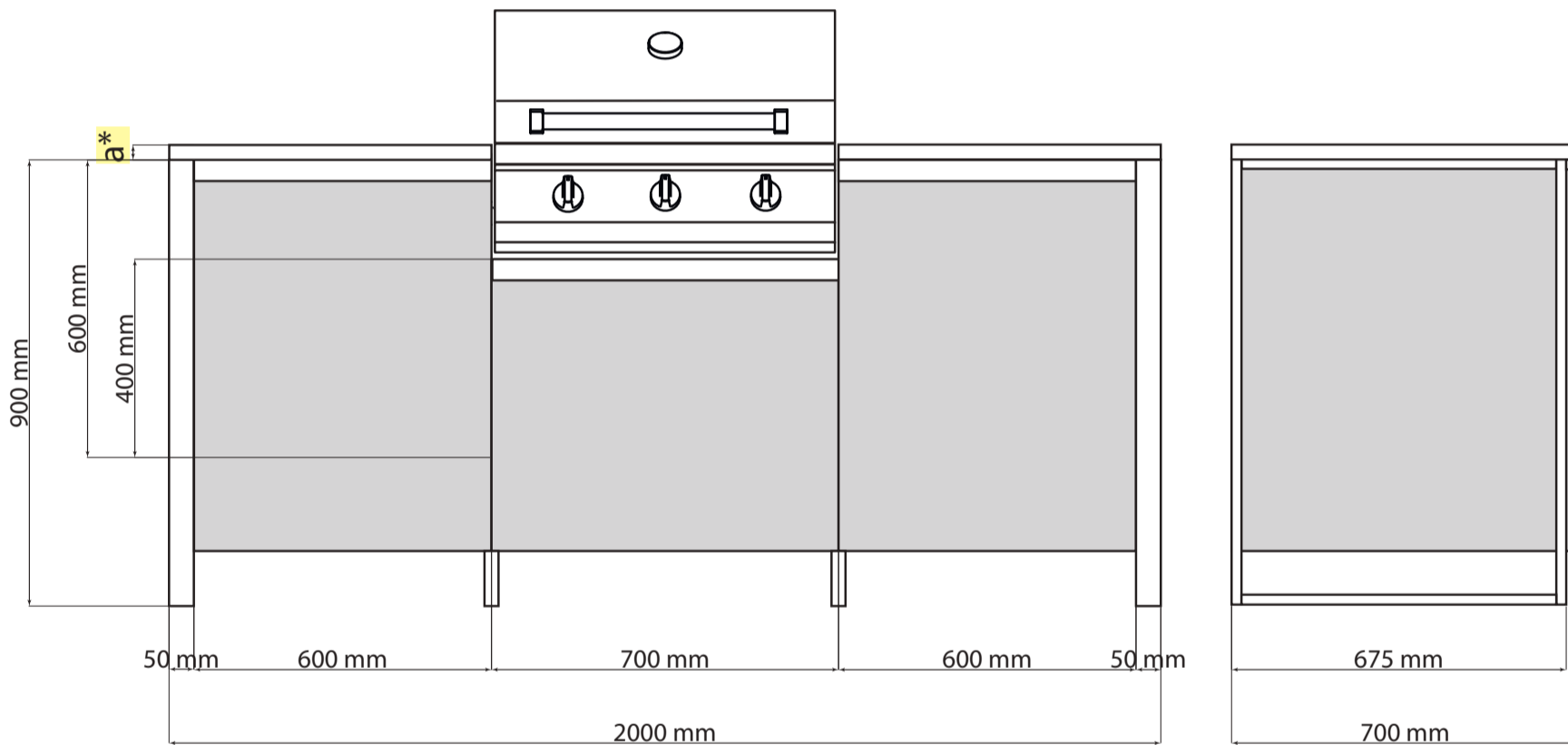

- *
- | | |
|--------------|--------------|
| HPL top | S.STEEL top |
| • a = 12 mm | • a = 30 mm |
| • b = 370 mm | • b = 400 mm |
| • c = 135 mm | • c = 150 mm |
| • d = 430 mm | • d = 400 mm |

overall features and composition



BASE PRODUCTS

CODE	DESCRIPTION	Q.TY	PRICE/UNIT	PRICE TOTAL
T6S-8 SX	Cabinet L=600 H=800 with door (left side opening)	1	1144 €	4110 €
T7C-6	Cabinet L=700 H=400 with drawer	1	1282 €	
T6S-8 DX	Cabinet L=600 H=600 with door (right side opening)	1	1144 €	
TA-F8	Infill side panel	4	135 €	



DOOR/DRAWER COLOURS

CODE	COLOUR	DESCRIPTION	Q.TY	PRICE/UNIT	PRICE TOTAL
	 SS	Stainless steel	3	INCLUDED	-
ODC-CO NF	 NF	Nero Fumo	3	431 €	1293 €
ODC-CO SA	 SA	Sabbia	3	431 €	1293 €
ODC-CO NA	 NA	Nuvola	3	431 €	1293 €

HANDLES AND STRUCTURE FINISH

CODE	FINISH	DESCRIPTION	Q.TY	PRICE/UNIT	PRICE TOTAL
TA-TT9 N	 Nickel N	Frame structure, handles, support feet in nickel finish	2	444 €	1023 €
TA-KC8 N			1	135 €	
TA-TT9 A	 Nero A	Frame structure, handles, support feet in matt black finish	2	444 €	1023 €
TA-KC8 A			1	135 €	

COUNTERTOPS

CODE	TOP FINISH	DESCRIPTION	Q.TY	PRICE/UNIT	PRICE TOTAL
TA-TOP20L-L		HPL countertop - LAVAGNA	1	529 €	1438 €
TA-TOP20-L			1	367 €	
TA-L4		Built-in s.steel sink bowl 370x430	1	542 €	
TA-TOP20L-Q		HPL countertop - QUERCIA	1	529 €	1438 €
TA-TOP20-Q			1	367 €	
TA-L4		Built-in s.steel sink bowl 370x430	1	542 €	

CODE	TOP FINISH	DESCRIPTION	Q.TY	PRICE/UNIT	PRICE TOTAL
TA-TOP20L-S		AISI 316 S. STEEL countertop and built-in s.steel sink bowl 400x400	1	2207 €	4374 €
TA-TOP20-S			1	2167 €	









ACCESSORIES AND BARBECUE





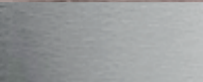

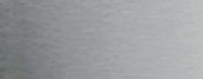

CODE	DESCRIPTION	Q.TY	PRICE/UNIT	PRICE TOTAL
MPC	Professional faucet with pull-out spray	1	649 €	5470 €
T7-3G	Bbq top 19 kW. Insulated double-layer lid with thermometer	1	4610 €	
TA-B7	Filler shelf for bbq installation	1	135 €	
TA-T7104	Rear junction for bbq top	1	84 €	



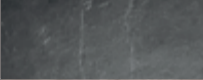

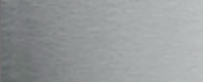

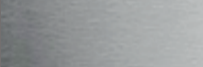

OPTIONAL KIT FOR ISLAND INSTALLATION





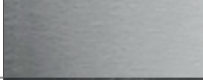

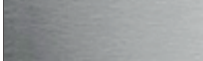

CODE	DESCRIPTION	Q.TY	PRICE/UNIT	PRICE TOTAL
TA-R6X8	Infill rear panel L=600 H=800	2	151 €	554 €
TA-R7X8	Infill rear panel L=700 H=800	1	168 €	
TA-T7129	Rear junction for bbq top	1	84 €	
TA-TOPIS20L-L	HPL countertop - LAVAGNA	1	996 €	2373 €
TA-TOPIS20-L		1	835 €	
TA-L4	Built-in s.steel sink bowl 370x430	1	542 €	2373 €
TA-TOPIS20L-Q	HPL countertop - QUERCIA	1	996 €	
TA-TOPIS20-Q		1	835 €	
TA-L4	Built-in s.steel sink bowl 370x430	1	542 €	
TA-TOPIS20L-S	AISI 316 S. STEEL countertop and built-in s.steel sink bowl 400x400	1	2779 €	5521 €
TA-TOPIS20-S		1	2742 €	

overall prices

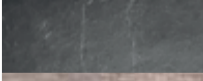
COLOUR		FINISH		TOP		CODE	PRICE
	SS		N		L	T20-80 SS-N-L	12049 €
					Q	T20-80 SS-N-Q	12049 €
					S	T20-80 SS-N-S	14985 €
			A		L	T20-80 SS-A-L	12049 €
					Q	T20-80 SS-A-Q	12049 €
					S	T20-80 SS-A-S	14985 €

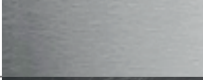
COLOUR		FINISH		TOP		CODE	PRICE
	NF		N		L	T20-80 NF-N-L	13342 €
					Q	T20-80 NF-N-Q	13342 €
					S	T20-80 NF-N-S	16278 €
			A		L	T20-80 NF-A-L	13342 €
					Q	T20-80 NF-A-Q	13342 €
					S	T20-80 NF-A-S	16278 €

COLOUR		FINISH		TOP		CODE	PRICE
	SA		N		L	T20-80 SA-N-L	13342 €
					Q	T20-80 SA-N-Q	13342 €
					S	T20-80 SA-N-S	16278 €
			A		L	T20-80 SA-A-L	13342 €
					Q	T20-80 SA-A-Q	13342 €
					S	T20-80 SA-A-S	16278 €

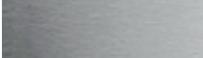
COLOUR		FINISH		TOP		CODE	PRICE
	NA		N		L	T20-80 NA-N-L	13342 €
					Q	T20-80 NA-N-Q	13342 €
					S	T20-80 NA-N-S	16278 €
			A		L	T20-80 NA-A-L	13342 €
					Q	T20-80 NA-A-Q	13342 €
					S	T20-80 NA-A-S	16278 €



dimensions



Aisi 316
The exterior of all modules and barbecues is made of Aisi 316 marine-grade stainless steel.

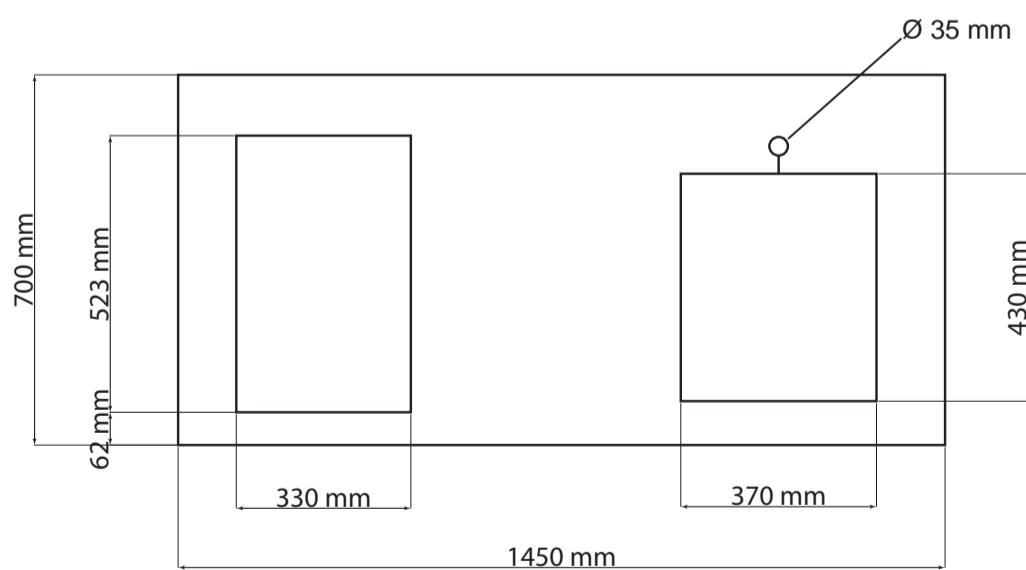
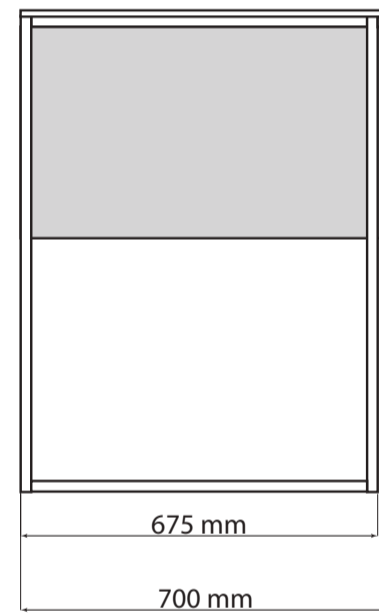
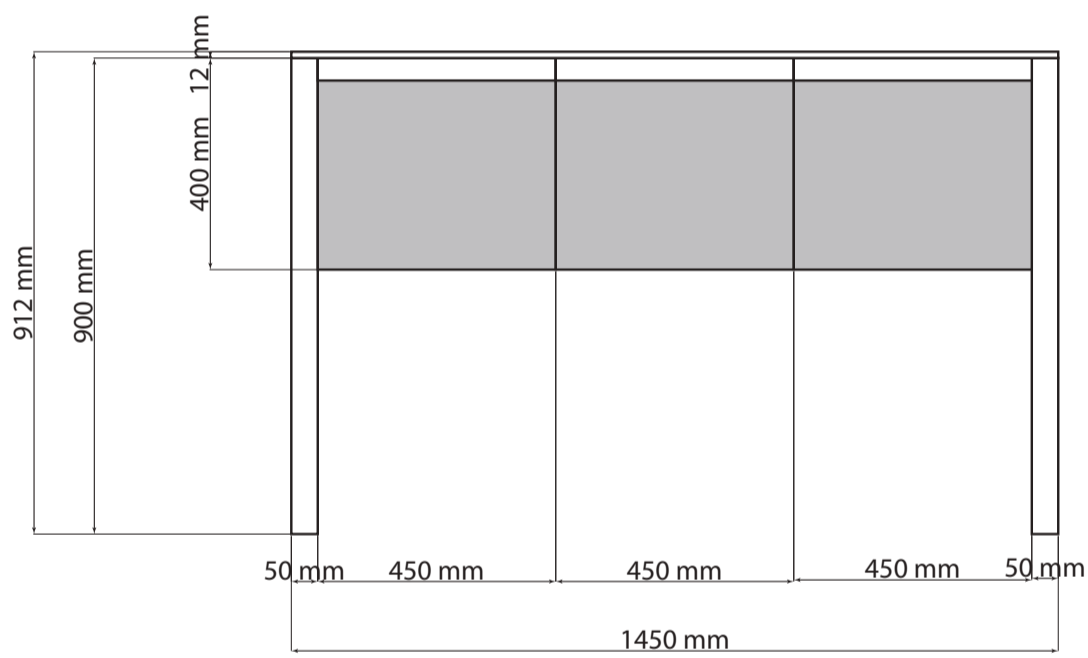

overall features and composition



BASE PRODUCTS

CODE	DESCRIPTION	Q.TY	PRICE/UNIT	PRICE TOTAL
T4S-4 SX	Cabinet L=450 H=400 with door (left side opening)	1	909 €	3093 €
T4C-4	Cabinet L=450 H=400 with drawer	1	1073 €	
T4S-4 DX	Cabinet L=450 H=400 with door (right side opening)	1	909 €	
TA-F4	Infill side panel	2	101 €	

DOOR/DRAWER COLOURS

CODE	COLOUR	DESCRIPTION	Q.TY	PRICE/UNIT	PRICE TOTAL
	 SS	Stainless steel	3	INCLUDED	-
ODC-CO NF	 NF	Nero Fumo	3	431 €	1293 €
ODC-CO SA	 SA	Sabbia	3	431 €	1293 €
ODC-CO NA	 NA	Nuvola	3	431 €	1293 €

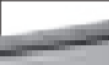
HANDLES AND STRUCTURE FINISH

CODE	FINISH	DESCRIPTION	Q.TY	PRICE/UNIT	PRICE TOTAL
TA-TT9 N	 Nickel N	Frame structure, handles in nickel finish	2	444 €	1023 €
TA-KC4 N			1	135 €	
TA-TT9 A	 Nero A	Frame structure, handles in matt black finish	2	444 €	1023 €
TA-KC4 A			1	135 €	

COUNTERTOPS



CODE	TOP FINISH	DESCRIPTION	Q.TY	PRICE/UNIT	PRICE TOTAL
TA-TOP15LW-L		HPL countertop - LAVAGNA	1	942 €	1484 €
TA-L4		Built-in s.steel sink bowl 370X430	1	542 €	
TA-TOP15LW-Q		HPL countertop - QUERCIA	1	942 €	1484 €
TA-L4		Built-in s.steel sink bowl 370X430	1	542 €	





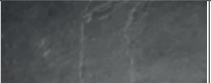

ACCESSORIES AND BARBECUE

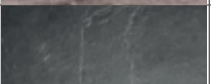
CODE	DESCRIPTION	Q.TY	PRICE/UNIT	PRICE TOTAL
MPC	Professional faucet with pull-out spray	1	649 €	1490 €
W4-1	Built-in rapid burner with knob	1	841 €	





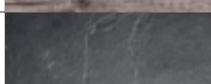

OPTIONAL KIT FOR ISLAND INSTALLATION

CODE	DESCRIPTION	Q.TY	PRICE/UNIT	PRICE TOTAL
TA-R4X4	Infill rear panel L=450 H=400	3	101 €	303 €
TA-TOPIS15LW-L	HPL countertop - LAVAGNA	1	1989 €	2531 €
TA-L4	Built-in s.steel sink bowl 370X430	1	542 €	
TA-TOPIS15LW-Q	HPL countertop - QUERCIA	1	1989 €	2531 €
TA-L4	Built-in s.steel sink bowl 370X430	1	542 €	

COLOUR		FINISH		TOP		CODE	PRICE
	SS		N		L	T15-40 SS-N-L	7090 €
					Q	T15-40 SS-N-Q	7090 €
			A		L	T15-40 SS-A-L	7090 €
					Q	T15-40 SS-A-Q	7090 €

COLOUR		FINISH		TOP		CODE	PRICE
	NF		N		L	T15-40 NF-N-L	8383 €
					Q	T15-40 NF-N-Q	8383 €
			A		L	T15-40 NF-A-L	8383 €
					Q	T15-40 NF-A-Q	8383 €

COLOUR		FINISH		TOP		CODE	PRICE
	SA		N		L	T15-40 SA-N-L	8383 €
					Q	T15-40 SA-N-Q	8383 €
			A		L	T15-40 SA-A-L	8383 €
					Q	T15-40 SA-A-Q	8383 €

COLOUR		FINISH		TOP		CODE	PRICE
	NA		N		L	T15-40 NA-N-L	8383 €
					Q	T15-40 NA-N-Q	8383 €
			A		L	T15-40 NA-A-L	8383 €
					Q	T15-40 NA-A-Q	8383 €



dimensions



Aisi 316 The exterior of all modules and barbecues is made of Aisi 316 marine-grade stainless steel.

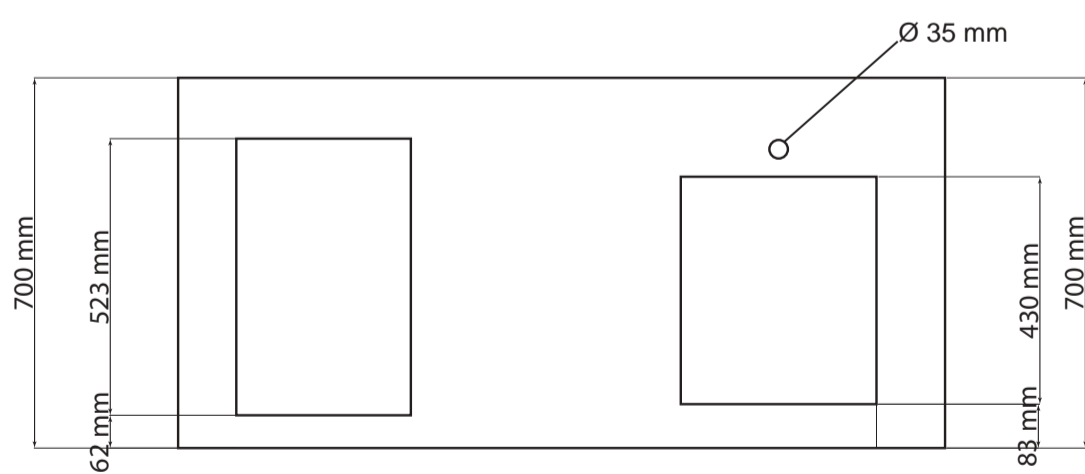
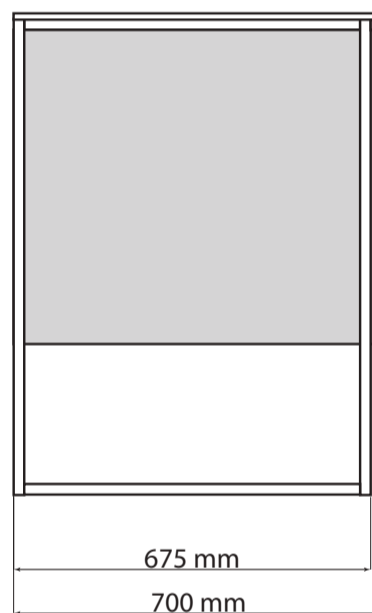
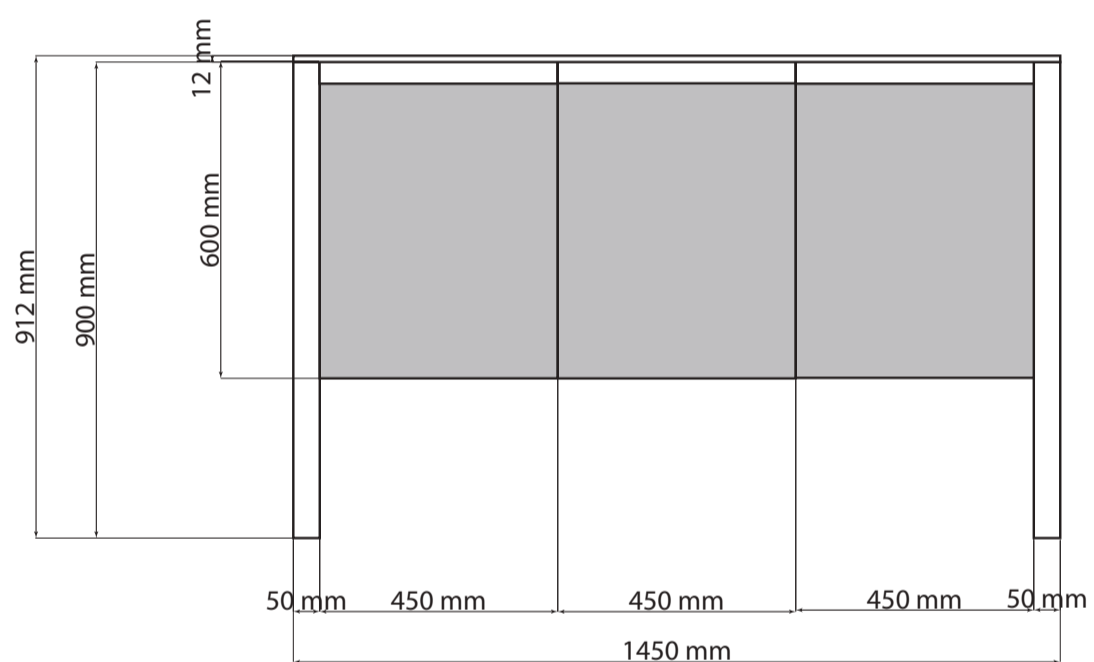

overall features and composition



BASE PRODUCTS

CODE	DESCRIPTION	Q.TY	PRICE/UNIT	PRICE TOTAL
T4S-6 SX	Cabinet L=450 H=600 with door (left side opening)	1	1006 €	3254 €
T4S-6 DX	Cabinet L=450 H=600 with door (right side opening)	2	1006 €	
TA-F6	Infill side panel	2	118 €	

DOOR/DRAWER COLOURS

CODE	COLOUR	DESCRIPTION	Q.TY	PRICE/UNIT	PRICE TOTAL
	 SS	Stainless steel	3	INCLUDED	-
ODC-CO NF	 NF	Nero Fumo	3	431 €	1293 €
ODC-CO SA	 SA	Sabbia	3	431 €	1293 €
ODC-CO NA	 NA	Nuvola	3	431 €	1293 €

HANDLES AND STRUCTURE FINISH

CODE	FINISH	DESCRIPTION	Q.TY	PRICE/UNIT	PRICE TOTAL
TA-TT9 N	 Nickel N	Frame structure, handles in nickel finish	2	444 €	1023 €
TA-KC6 N			1	135 €	
TA-TT9 A	 Nero A	Frame structure, handles in matt black finish	2	444 €	1023 €
TA-KC6 A			1	135 €	

COUNTERTOPS







CODE	TOP FINISH	DESCRIPTION	Q.TY	PRICE/UNIT	PRICE TOTAL
TA-TOP15LW-L		HPL countertop - LAVAGNA	1	942 €	1484 €
TA-L4		Built-in s.steel sink bowl 370X430	1	542 €	
TA-TOP15LW-Q		HPL countertop - QUERCIA	1	942 €	1484 €
TA-L4		Built-in s.steel sink bowl 370X430	1	542 €	





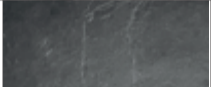

ACCESSORIES AND BARBECUE







CODE	DESCRIPTION	Q.TY	PRICE/UNIT	PRICE TOTAL
MPC	Professional faucet with pull-out spray	1	649 €	1490 €
W4-1	Built-in rapid burner with knob	1	841 €	





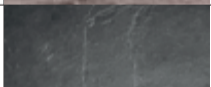

OPTIONAL KIT FOR ISLAND INSTALLATION

CODE	DESCRIPTION	Q.TY	PRICE/UNIT	PRICE TOTAL
TA-R4X6	Infill rear panel L=450 H=600	3	118 €	354 €
TA-TOPIS15LW-L	HPL countertop - LAVAGNA	1	1989 €	2531 €
TA-L4	Built-in s.steel sink bowl 370X430	1	542 €	
TA-TOPIS15LW-Q	HPL countertop - QUERCIA	1	1989 €	2531 €
TA-L4	Built-in s.steel sink bowl 370X430	1	542 €	

COLOUR		FINISH		TOP		CODE	PRICE
	SS		N		L	T15-60 SS-N-L	7251 €
					Q	T15-60 SS-N-Q	7251 €
			A		L	T15-60 SS-A-L	7251 €
					Q	T15-60 SS-A-Q	7251 €

COLOUR		FINISH		TOP		CODE	PRICE
	NF		N		L	T15-60 NF-N-L	8544 €
					Q	T15-60 NF-N-Q	8544 €
			A		L	T15-60 NF-A-L	8544 €
					Q	T15-60 NF-A-Q	8544 €

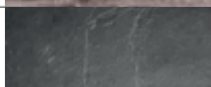
COLOUR		FINISH		TOP		CODE	PRICE
	SA		N		L	T15-60 SA-N-L	8544 €
					Q	T15-60 SA-N-Q	8544 €
			A		L	T15-60 SA-A-L	8544 €
					Q	T15-60 SA-A-Q	8544 €

COLOUR		FINISH		TOP		CODE	PRICE
	NA		N		L	T15-60 NA-N-L	8544 €
					Q	T15-60 NA-N-Q	8544 €
			A		L	T15-60 NA-A-L	8544 €
					Q	T15-60 NA-A-Q	8544 €



dimensions



Aisi 316 The exterior of all modules and barbecues is made of Aisi 316 marine-grade stainless steel.

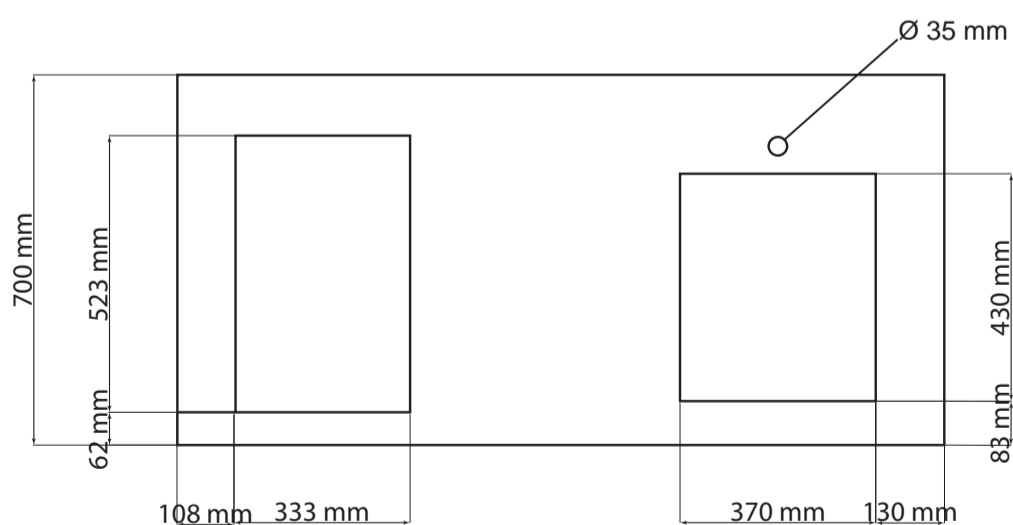
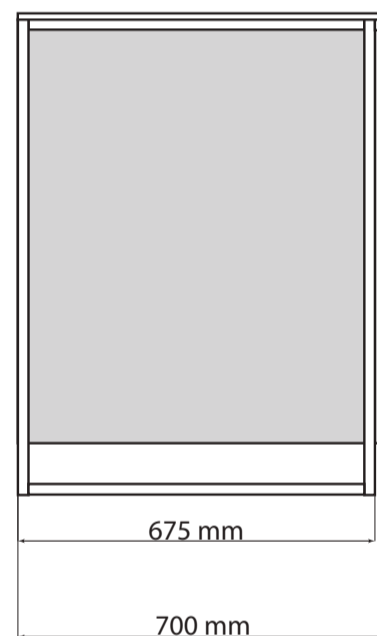
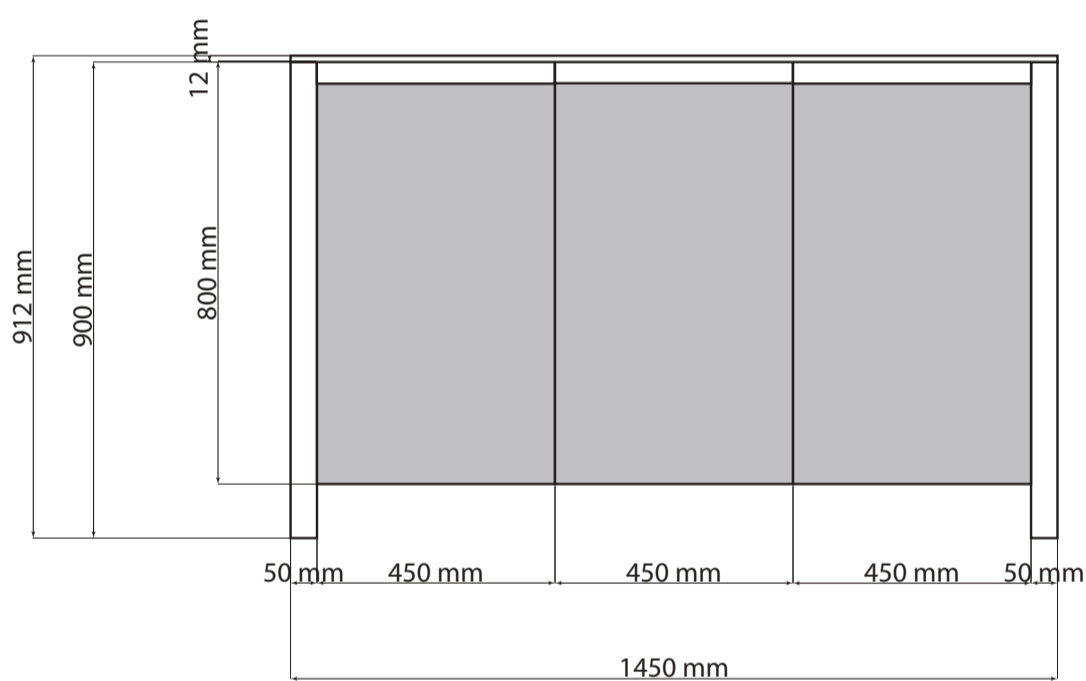

overall features and composition



BASE PRODUCTS

CODE	DESCRIPTION	Q.TY	PRICE/UNIT	PRICE TOTAL
T4S-8 SX	Cabinet L=450 H=800 with door (left side opening)	1	1073 €	3489 €
T4S-8 DX	Cabinet L=450 H=800 with door (right side opening)	2	1073 €	
TA-F8	Infill side panel	2	135 €	

DOOR/DRAWER COLOURS

CODE	COLOUR	DESCRIPTION	Q.TY	PRICE/UNIT	PRICE TOTAL
	 SS	Stainless steel	3	INCLUDED	-
ODC-CO NF	 NF	Nero Fumo	3	431 €	1293 €
ODC-CO SA	 SA	Sabbia	3	431 €	1293 €
ODC-CO NA	 NA	Nuvola	3	431 €	1293 €

HANDLES AND STRUCTURE FINISH

CODE	FINISH	DESCRIPTION	Q.TY	PRICE/UNIT	PRICE TOTAL
TA-TT9 N	 Nickel N	Frame structure, handles in nickel finish	2	444 €	1023 €
TA-KC8 N			1	135 €	
TA-TT9 A	 Nero A	Frame structure, handles in matt black finish	2	444 €	1023 €
TA-KC8 A			1	135 €	

COUNTERTOPS







CODE	TOP FINISH	DESCRIPTION	Q.TY	PRICE/UNIT	PRICE TOTAL
TA-TOP15LW-L		HPL countertop - LAVAGNA	1	942 €	1484 €
TA-L4		Built-in s.steel sink bowl 370X430	1	542 €	
TA-TOP15LW-Q		HPL countertop - QUERCIA	1	942 €	1484 €
TA-L4		Built-in s.steel sink bowl 370X430	1	542 €	





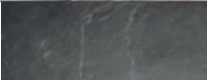

ACCESSORIES AND BARBECUE





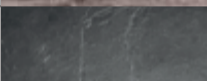

CODE	DESCRIPTION	Q.TY	PRICE/UNIT	PRICE TOTAL
MPC	Professional faucet with pull-out spray	1	649 €	1490 €
W4-1	Built-in rapid burner with knob	1	841 €	





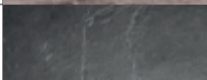

OPTIONAL KIT FOR ISLAND INSTALLATION

CODE	DESCRIPTION	Q.TY	PRICE/UNIT	PRICE TOTAL
TA-R4X8	Infill rear panel L=450 H=800	3	135 €	405 €
TA-TOPIS15LW-L	HPL countertop - LAVAGNA	1	1989 €	2531 €
TA-L4	Built-in s.steel sink bowl 370X430	1	542 €	
TA-TOPIS15LW-Q	HPL countertop - QUERCIA	1	1989 €	2531 €
TA-L4	Built-in s.steel sink bowl 370X430	1	542 €	

COLOUR		FINISH		TOP		CODE	PRICE
	SS		N		L	T15-80 SS-N-L	7486 €
					Q	T15-80 SS-N-Q	7486 €
			A		L	T15-80 SS-A-L	7486 €
					Q	T15-80 SS-A-Q	7486 €

COLOUR		FINISH		TOP		CODE	PRICE
	NF		N		L	T15-80 NF-N-L	8779 €
					Q	T15-80 NF-N-Q	8779 €
			A		L	T15-80 NF-A-L	8779 €
					Q	T15-80 NF-A-Q	8779 €

COLOUR		FINISH		TOP		CODE	PRICE
	SA		N		L	T15-80 SA-N-L	8779 €
					Q	T15-80 SA-N-Q	8779 €
			A		L	T15-80 SA-A-L	8779 €
					Q	T15-80 SA-A-Q	8779 €

COLOUR		FINISH		TOP		CODE	PRICE
	NA		N		L	T15-80 NA-N-L	8779 €
					Q	T15-80 NA-N-Q	8779 €
			A		L	T15-80 NA-A-L	8779 €
					Q	T15-80 NA-A-Q	8779 €

GEA customized configurations

1) Frame structure kit

1.1. Each GEA configuration requires two supporting legs TA-TT9.

1.2. The maximum allowable length for each composition with a height of 600 mm or 800 mm is 3550 mm.

The maximum allowable length for each composition with a height of 400 mm is 1800 mm.

If this length is exceeded, an additional supporting leg TA-TT9 will be required.

A single-piece countertop must not exceed 3550 mm; beyond this length, it will be provided in at least two parts.

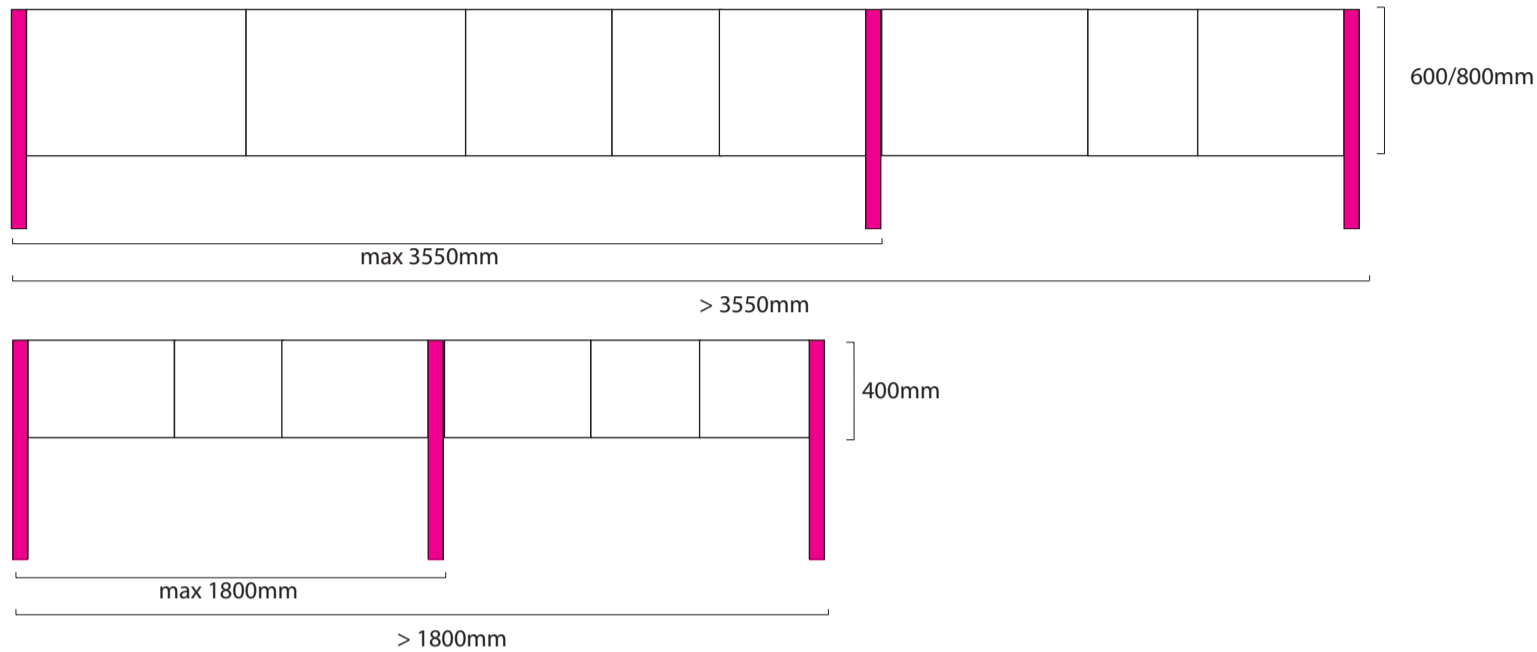

2) Definition of the units' height

2.1. Gea kitchen units are available in heights of 800 mm, 600 mm, and 400 mm.

It is possible to set a fixed height for the whole configuration.

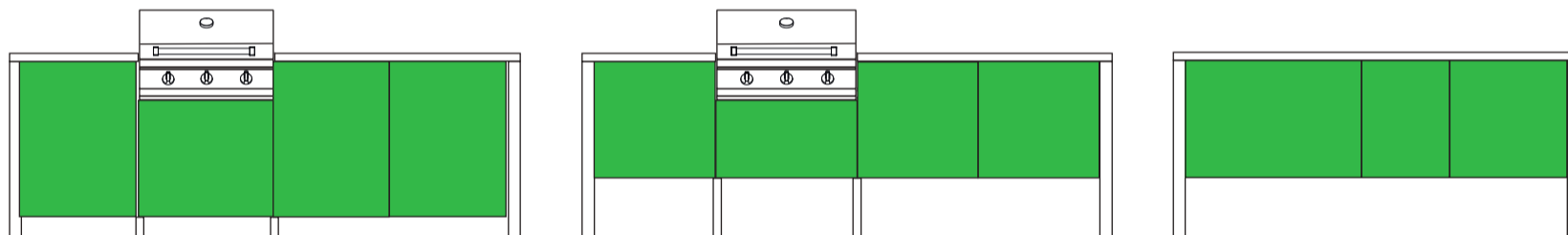

2.2. Configurations can have units of different heights. In this case, the top alignment must be maintained, and a supporting leg TA-TT9 must always be placed between units of different heights (see figs. A and B).

2.3. It is possible to include a unit with a different height aligned at the base (see fig. C). In this case:

- Only one unit of lower height can be included in the configuration; after this, the configuration height (equal to that of the other modules) must be restored.
- The unit cannot be placed next to the bbq top, nor can it be positioned at the ends of the configuration.
- The unit must be the height immediately below that of the other modules in the configuration (H=400 for H=600 configurations; H=600 for H=800 configurations).
- It will not be possible to select a stainless steel countertop.

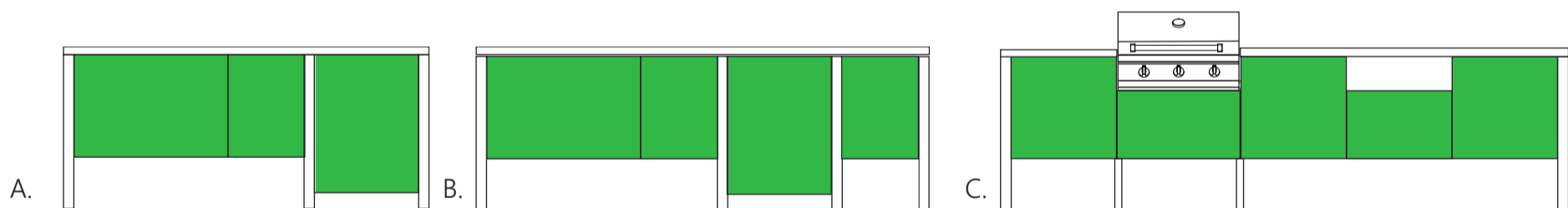

For GEA kitchens where a module is only aligned at the bottom (see figure C.), it is recommended to provide **infill side panels** at the height of the adjacent modules and a **Infill upper panels** for units not aligned with the countertop at the width of the lowest module.

2.4. Examples of non-allowed configurations:

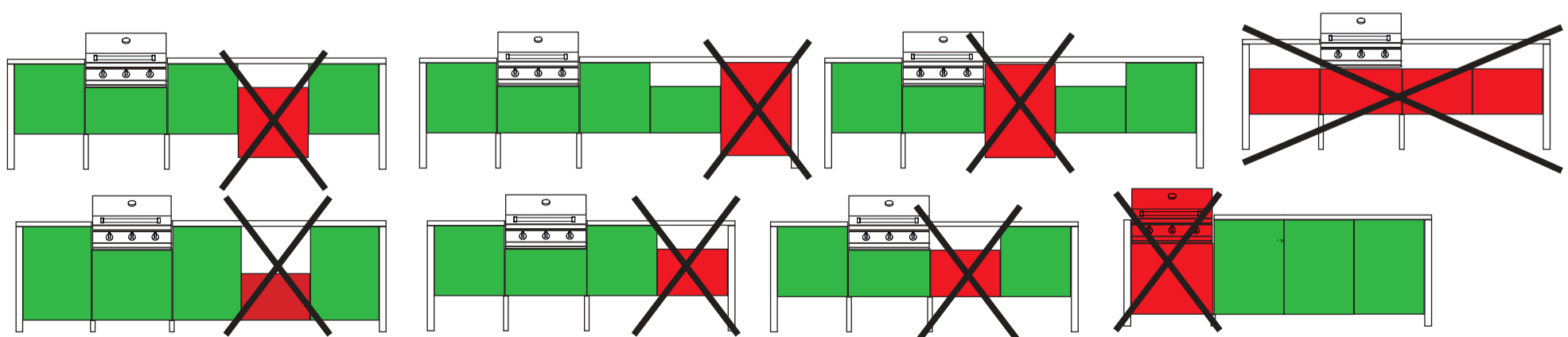

3) Barbecue installation

3.1. When a barbecue top is included in the configuration, it must be placed on a lower-height unit, as follows:

- For configurations with units up to 400 mm in height, the W5-2 bbq can be installed on the dedicated T6C-2* unit (see fig. A).
- For configurations with units up to 600 mm in height, the bbq should be placed on a 400 mm high module.
- For configurations with units up to 800 mm in height, the bbq should be placed on a 600 mm high module.

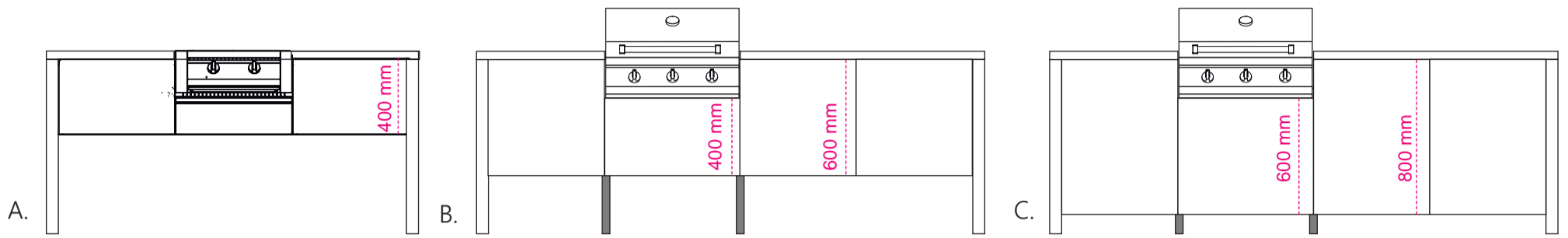

3.2. The installation of the bbq top always requires a FILLER SHELF:

- For bbq tops T9-4G and W9-4, use code TA-B9
- For bbq tops T7-3G and W7-3, use code TA-B7
- For bbq top W5-2*, use code TA-B6 or, when installing the bbq on unit T6T-2, use code TA-B6-2

*Always needs lateral filler kit TA-KFW5

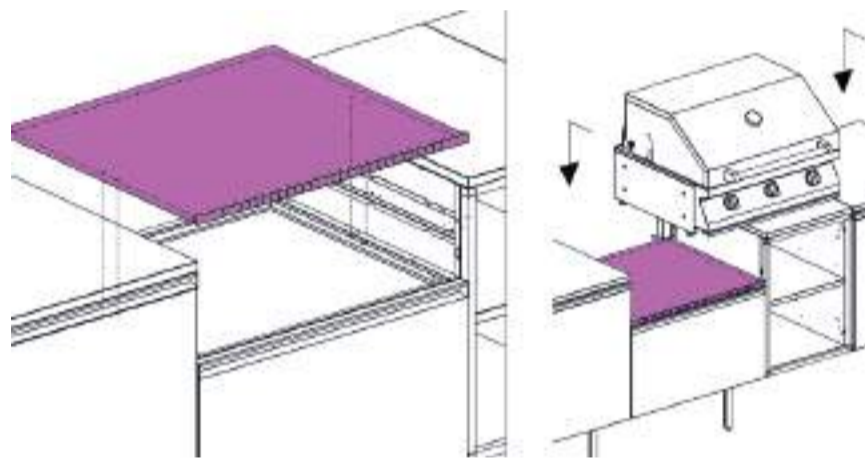

4) Kamado unit installation

4.1. In the case of including a T6C-6 BGE or T6C-8 BGE unit for accommodating a Kamado Big Green Egg size Large (not included) in the configuration:

- The T6C-6 BGE or T6C-8 BGE unit requires a supporting leg TA-TT9 at each end.
- All unit in the configuration must include INFILL REAR PANELS (see chapter 5).
- The choice of the countertop, if ordered with the configuration, must be one of the two available finishes in HPL (see chapter 8).
- The chosen countertop must be 725 mm deep.

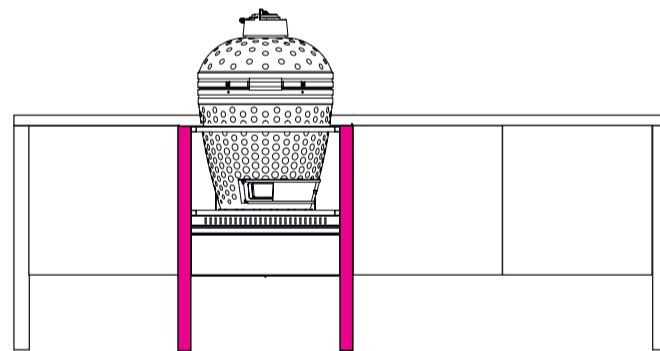

5) Infill panels

5.1. Two INFILL SIDE PANELS must always be included for the ends of the configuration and, where applicable, at both ends of the units housing a barbecue top or any unit of a different height. In all cases, H must correspond to the height of the tallest unit.

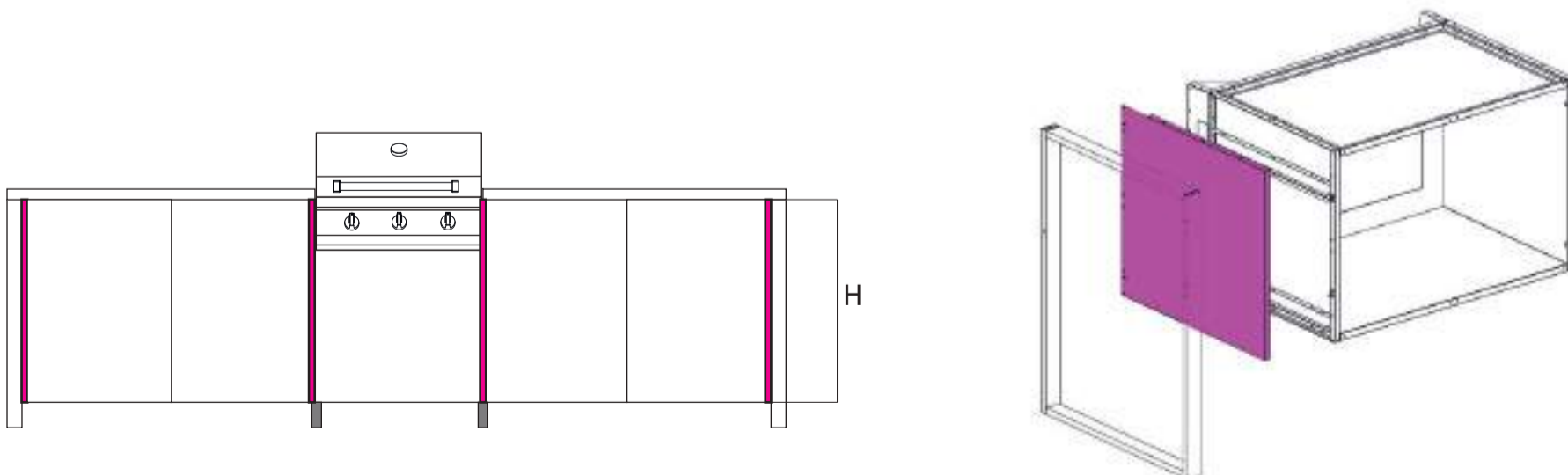

5.2. In the case of island installation, INFILL REAR PANELS must be included in a quantity equal to the number of units; the height of the panels must always match the height of the reference unit, except for the units housing barbecue tops. In this case, the height of the panel must be equal to the height of the base unit plus 200 mm, which is necessary to also cover the back of the barbecue.

6) Kitchen completion kit

6.1. Each configuration must include at least one TA-KC kitchen completion kit.

The kit includes two support feet, an anti-tip kit, a user manual, and an assembly manual.

The support feet must always be installed at the joints of the modules housing a barbecue top and at a maximum distance of 1800 mm (see fig. D).

It will be necessary to provide a sufficient number of completion kits to meet these requirements.

For configurations that are entirely aligned at the base, the height of the kit must match the height of the tallest module. For configurations with varying heights exceeding 1800 mm, an additional completion kit must be selected based on the height of the modules (see fig. D).

6.2. The kit must have the same finish as the selected finish for the individual modules (see chapter 7).

6.3. Compositions with module heights up to 400 mm do not require the installation of support feet.

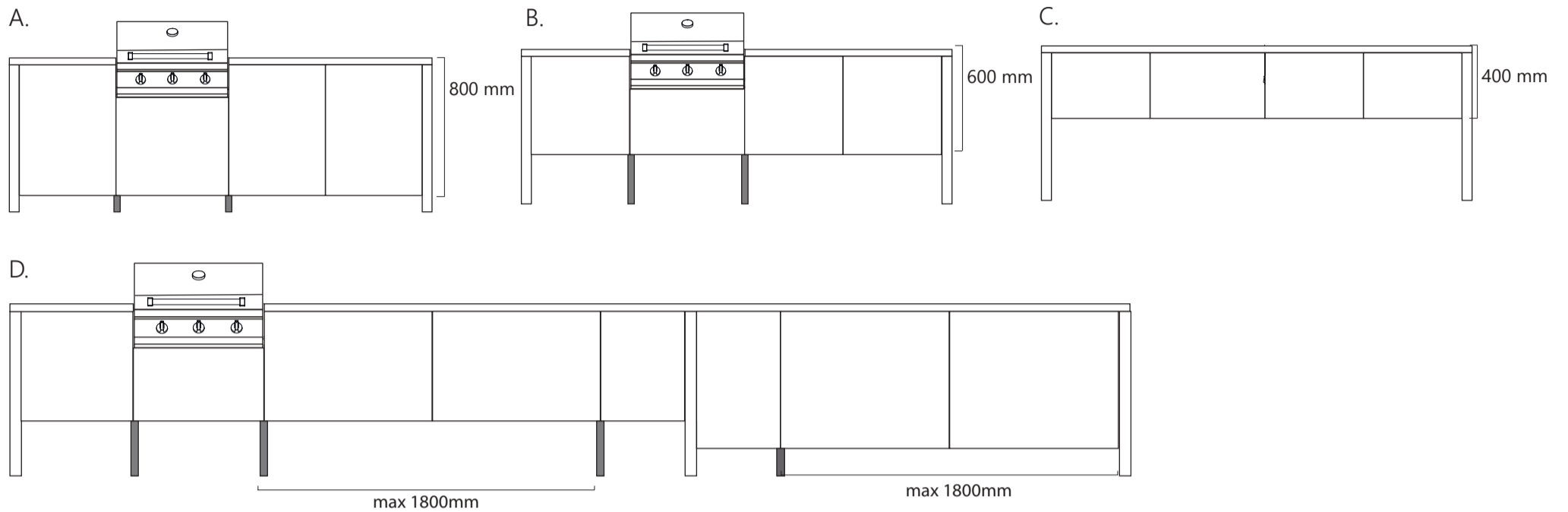

7) Finishes and colours

7.1. GEA modules offer the option to choose between two possible finishes for the legs and handles, as well as for the frame of the open shelving units.

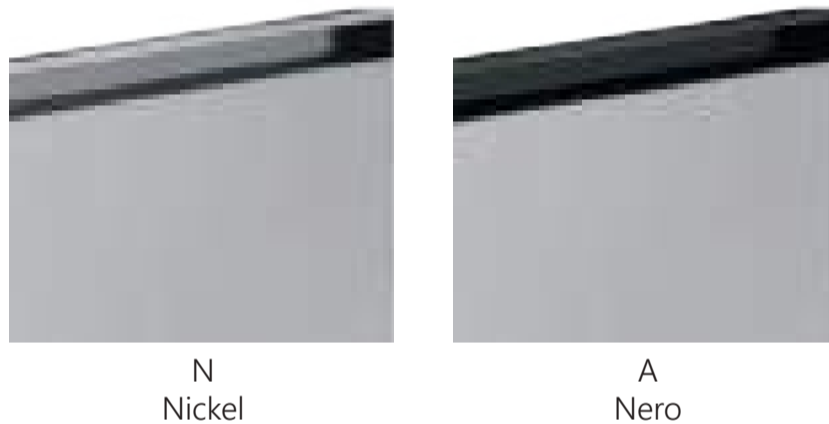

7.2. The drawers or doors can be in the standard stainless steel (SS) finish or in one of the following color options: Nero Fumo (NF), Sabbia (SA), or Nuvola (NA).



8) Custom countertops

8.1. GEA can be completed with any custom-made countertop purchased separately.

The HPL countertops with Quercia (Q) and Lavagna (L) finishes, as well as the Aisi 316 stainless steel (S) countertop, can be custom-designed for any personalized configuration.

A single-piece countertop must not exceed 3550 mm; beyond this length, it will be produced in at least two parts.



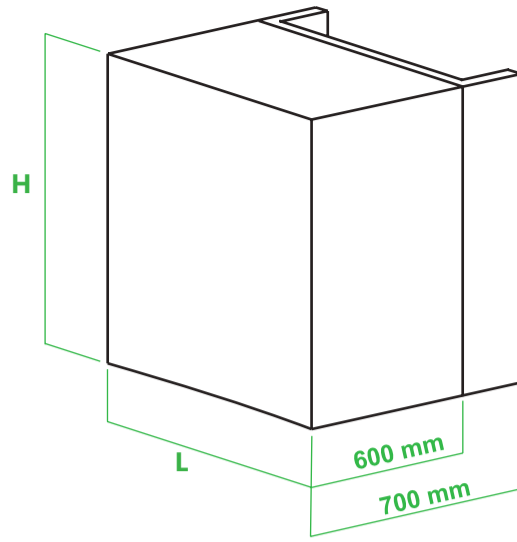

CABINETS

TYPE	H (mm)	L (mm)	DESCRIPTION	CODE	PRICE
	200	600	Unit for housing bbq top W5-2 designed for solutions H=400** with drawer	T6C-2	1110 €
	400	450	Cabinet with single big drawer	T4C-4	1073 €
	400	600	Cabinet with single big drawer	T6C-4	1144 €
	400	700	Cabinet with single big drawer	T7C-4	1212 €
	400	900	Cabinet with single big drawer	T9C-4	1420 €
	600	600	Cabinet with single big drawer - compatible with optional inner drawer TA-C6	T6C-6	1178 €
	600	700	Cabinet with single big drawer	T7C-6	1282 €
	600	900	Cabinet with single big drawer - compatible with optional inner drawer TA-C9	T9C-6	1491 €
	600	600	Cabinet with drawer H=200 mm, designed for housing Kamado Big Green Egg - size Large (not included)	T6C-6 BGE	1514 €
	800	600	Cabinet with drawer H=400 mm, designed for housing Kamado Big Green Egg - size Large (not included)	T6C-8 BGE	1582 €
		400	450	Cabinet with one shelf and one door, right side opening	T4S-4 DX
400		450	Cabinet with one shelf and one door, left side opening	T4S-4 SX	909 €
400		900	Cabinet with one shelf and two doors	T9S-4	1279 €
600		450	Cabinet with one shelf* and one door, right side opening	T4S-6 DX	1006 €
600		450	Cabinet with one shelf* and one door, left side opening	T4S-6 SX	1006 €
600		600	Cabinet with one shelf* and one door, right side opening	T6S-6 DX	1073 €
600		600	Cabinet with one shelf* and one door, left side opening	T6S-6 SX	1073 €
600		900	Cabinet with one shelf* and two doors	T9S-6	1215 €
800		450	Cabinet with one shelf* and one door, right side opening	T4S-8 DX	1073 €
800		450	Cabinet with one shelf* and one door, left side opening	T4S-8 SX	1073 €
800		600	Cabinet with one shelf* and one door, right side opening	T6S-8 DX	1144 €
800		600	Cabinet with one shelf* and one door, left side opening	T6S-8 SX	1144 €
800		600	Cabinet for housing refrigerator TA-FR, right side opening	T6S-8 FR DX	1447 €
800		600	Cabinet for housing refrigerator TA-FR, left side opening	T6S-8 FR SX	1447 €
800		900	Cabinet with one shelf* and two doors	T9S-8	1420 €
	600	450	Open cabinet with one shelf	T4G-6	868 €
	800	450	Open cabinet with one shelf	T4G-8	935 €

* the shelf can be easily removed to accommodate a gas cylinder.

To be always completed with lateral filler kit **TA-KFW5

CUSTOMIZATION FEE - TA-SP

+ 1514 €

STANDARD COLOUR



ON DEMAND COLOURS - ODC-CO

+ 431 €



COMPLEMENTARY PIECES AND INFILL PANELS

DESCRIPTION	H (mm)	L (mm)	CODE	PRICE
Load-bearing leg - nickel finish	-	-	TA-TT9 N	444 €
Load-bearing leg - black finish	-	-	TA-TT9 A	444 €
Kitchen completion kit - nickel finish	400	-	TA-KC4 N	135 €
Kitchen completion kit - black finish	400	-	TA-KC4 A	135 €
Kitchen completion kit - nickel finish	600	-	TA-KC6 N	135 €
Kitchen completion kit - black finish	600	-	TA-KC6 A	135 €
Kitchen completion kit - nickel finish	800	-	TA-KC8 N	135 €
Kitchen completion kit - black finish	800	-	TA-KC8 A	135 €
Infill side panel	400	-	TA-F4	101 €
	600	-	TA-F6	118 €
	800	-	TA-F8	135 €
Infill rear panel	400	450	TA-R4X4	101 €
	400	600	TA-R6X4	118 €
	400	700	TA-R7X4	125 €
	400	900	TA-R9X4	135 €
	600	450	TA-R4X6	118 €
	600	600	TA-R6X6	135 €
	600	700	TA-R7X6	145 €
	600	900	TA-R9X6	151 €
	800	450	TA-R4X8	135 €
	800	600	TA-R6X8	151 €
	800	700	TA-R7X8	168 €
800	900	TA-R9X8	185 €	
Infill upper panels for units not aligned with the countertop	-	450	TA-PV4	101 €
	-	600	TA-PV6	118 €
	-	700	TA-PV7	135 €
	-	900	TA-PV9	151 €
Rear junctions for bbq tops	-	600	TA-T6104	84 €
	-	600	TA-T6104-2	84 €
	-	600	TA-T6129	84 €
	-	600	TA-T6129-2	84 €
	-	700	TA-T7104	84 €
	-	700	TA-T7129	84 €
	-	900	TA-T9104	84 €
	-	900	TA-T9129	84 €
Inner drawer for drawer units H=600 and H=800	-	600	TA-C6	337 €
	-	900	TA-C9	370 €
Filler shelf for bbq installation	-	600	TA-B6	118 €
Filler shelf for bbq installation	-	700	TA-B7	135 €
Filler shelf for bbq installation	-	900	TA-B9	151 €
Lateral filler kit for bbq W5-2*	-	600	TA-KFW5	151 €

GEA accessories

BARBECUES, SINKS AND REFRIGERATOR

TYPE	DESCRIPTION	CODE	PRICE
	Rapid burner, cast iron grid, s.steel protective lid, metal control knob	W4-1	841 €
	2 burners, 18 dm ² cooking surface, 1 reversible plate (smooth/ribbed) + 1 grate, 12,5 kW, thermocouple. Compatible rear junction: TA-T6104 / TA-T6104-2* *When installed on T6C-2	W5-2	1773 €
	3 burners, 27 dm ² cooking surface, 1 reversible plate (smooth/ribbed) + 2 grates, 19 kW, thermocouple. Compatible rear junction: TA-T7104	W7-3	2931 €
	4 burners, 36 dm ² cooking surface, 1 reversible plate (smooth/ribbed) + 3 grates, 25 kW, thermocouple. Compatible rear junctions: TA-T9104	W9-4	3601 €
	3 burners, 27 dm ² cooking surface, 1 reversible plate (smooth/ribbed) + 2 grates, 19 kW, thermocouple, double-layer insulated s.steel lid with thermometer. Compatible rear junction: TA-T7104	T7-3G	4610 €
	4 burners, 36 dm ² cooking surface, 1 reversible plate (smooth/ribbed) + 3 grates, 25 kW, thermocouple, double-layer insulated s.steel lid with thermometer. Compatible rear junction: TA-T9104	T9-4G	5502 €
	Sink bowl 370x430	TA-L4	542 €
	Sink bowl 730x430	TA-L7	902 €
	Professional faucet with pull-out spray	MPC	649 €
	Stainless steel fridge-freezer, 90-liter capacity, LED lighting.	TA-FR	4980 €













GEA accessories

COMPATIBILITIES

	W4-1	W5-2	W7-3	T7-3G	W9-4	T9-4G	TA-L4	TA-L7	TA-FR
T4C-4	✓	✗	✗	✗	✗	✗	✓	✗	✗
T4S-4 DX T4S-4 SX	✓	✗	✗	✗	✗	✗	✓	✗	✗
T4S-6 DX T4S-6 SX	✓	✗	✗	✗	✗	✗	✓	✗	✗
T4G-6	✓	✗	✗	✗	✗	✗	✓	✗	✗
T4S-8 DX T4S-8 SX	✓	✗	✗	✗	✗	✗	✓	✗	✗
T4G-8	✓	✗	✗	✗	✗	✗	✓	✗	✗
T6C-4	✓	✓*	✗	✗	✗	✗	✓	✗	✗
T6C-6	✓	✓*	✗	✗	✗	✗	✓	✗	✗
T6S-6 DX T6S-6 SX	✓	✓*	✗	✗	✗	✗	✓	✗	✗
T6S-8 DX T6S-8 SX	✓	✗	✗	✗	✗	✗	✓	✗	✗
T6S-8 FR DX T6S-8 FR SX	✗	✗	✗	✗	✗	✗	✗	✗	✓
T7C-4	✓	✗	✓	✓	✗	✗	✓	✗	✗
T7C-6	✓	✗	✓	✓	✗	✗	✓	✗	✗
T9C-4	✓	✗	✗	✗	✓	✓	✓	✓	✗
T9S-6	✓	✗	✗	✗	✓	✓	✓	✓	✗
T9C-6	✓	✗	✗	✗	✓	✓	✓	✓	✗
T9S-8	✓	✗	✗	✗	✗	✗	✓	✓	✗

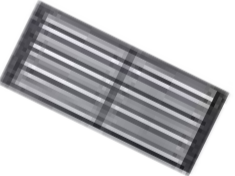
*To be always completed with lateral filler kit **TA-KFW5**

GEA extra accessories

TYPE	DESCRIPTION	CODE	PRICE
	Motorized rotisserie for T7-3G	AB-GA7	387 €
	Motorized rotisserie for T9-4G	AB-GA9	400 €
	Barbecue tool kit	AB-KU	249 €
	S.Steel Teppanyaki plate for W7-3 and T7-3G	AB-TY	700 €
	S.Steel Teppanyaki plate for W9-4 and T9-4G	AB-TY3	798 €
	S.Steel flame tamer for W5-2, W7-3, T7-3G, W9-4, T9-4G	AB-DX	323 €
	Smoking tray for T7-3G, T9-4G	AB-KA	219 €
	Charcoal tray for W5-2, W7-3, T7-3G, W9-4, T9-4G	AB-KC	323 €
	Cast iron reversible plate (smooth/ridged) for W5-2, W7-3, T7-3G, W9-4, T9-4G	AB-PD	299 €
	Cast iron grate for W5-2, W7-3, T7-3G, W9-4, T9-4G	AB-PA	299 €
	Stainless steel grate for W5-2, W7-3, T7-3G, W9-4, T9-4G	AB-PX	299 €
	Pizza kit with refractory stone and paddle for T7-3G, T9-4G	AB-P7	246 €
	Care and maintenance kit	SA-KP	77 €
	Custom-made cover in nautical fabric		<i>on demand</i>

SWING kitchens



SWING customized configurations

1) Unit types and sizes

Various types of Swing units are available:

- Barbecue units (700 mm and 900 mm)
- Cook unit (900 mm)
- Unit for housing the Kamado Big Green Egg (not included) (700 mm)
- Sink units (700 mm, 900 mm, and 1200 mm)
- Refrigerator unit with steel or glass door (700 mm)
- Ice maker unit (700 mm)
- Units with worktops and storage space (450 mm, 700 mm, 900 mm, 1200 mm)

All units have a standard height of 902 mm and a depth of 624 mm.

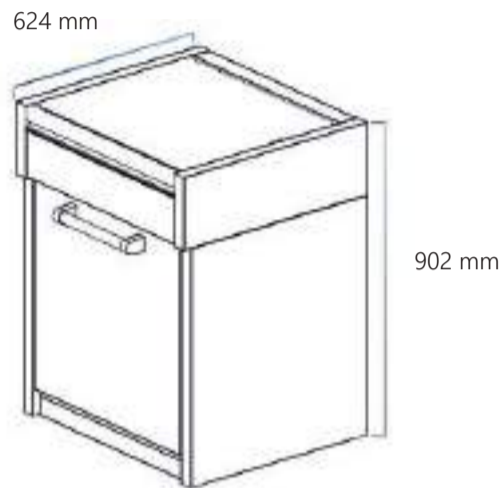

2) Types of installations

Swing configurations can be linear, L-shaped, or island.

For linear configurations, front junctions GA-EGI are available.

For L-shaped configurations, the self-supporting corner unit GMA-7 must be included.

For island configurations, the back panels AB-BP/SA-BP are available in all unit widths listed in the catalog.

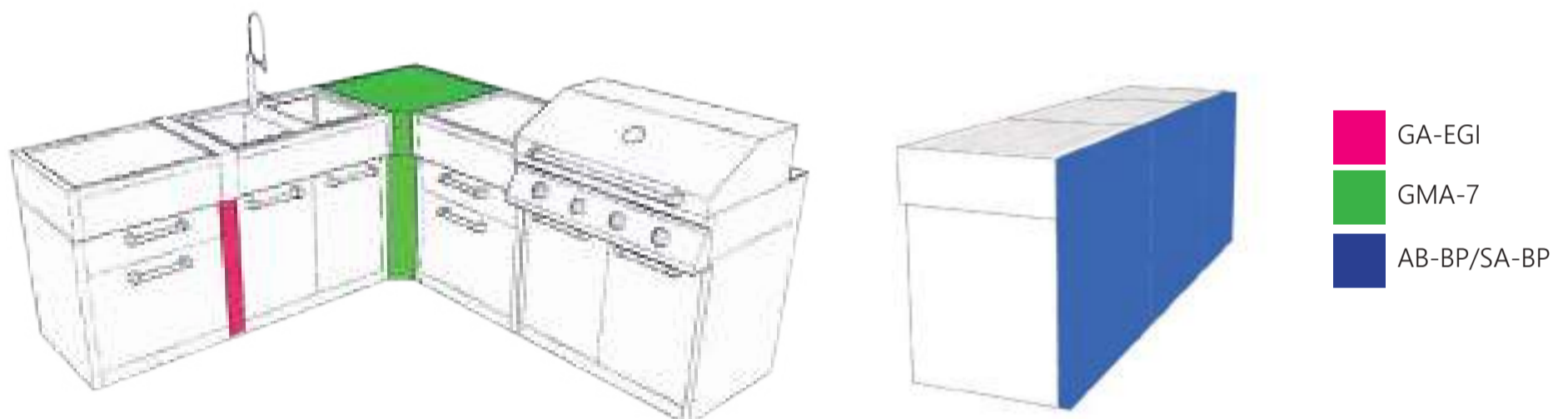

In configurations that include the unit for the Big Green Egg, code G7C-BGE, a 100 mm spacer GA-D/AB-D is required for each unit in the configuration.



3) Colours and worktops

The doors and drawers of the Swing units can have the standard Stainless Steel (SS) finish or be painted in Antracite (AN).



SS
Stainless steel



AN
Antracite

All units with a worktop can be completed with an HPL countertop/cutting board in Quercia finish (Q) or Lavagna finish (L).



Q
Quercia

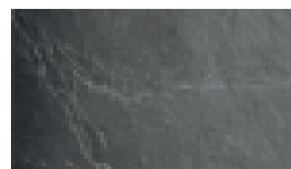

L
Lavagna

SWING units

Barbecue Units

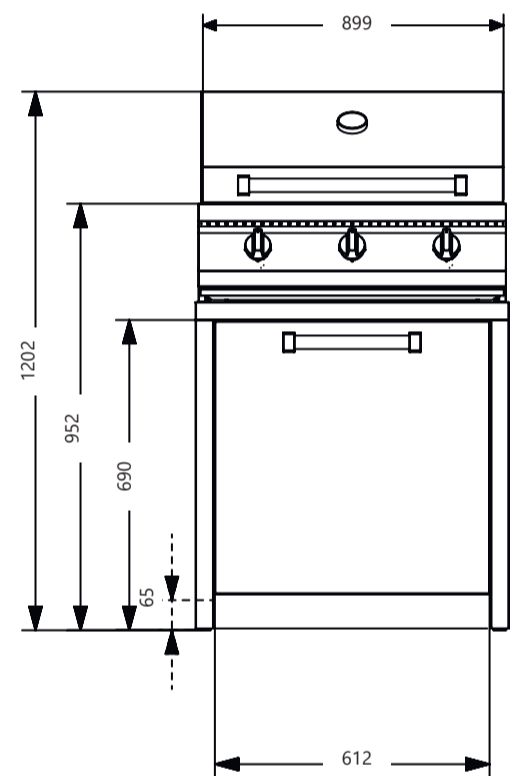
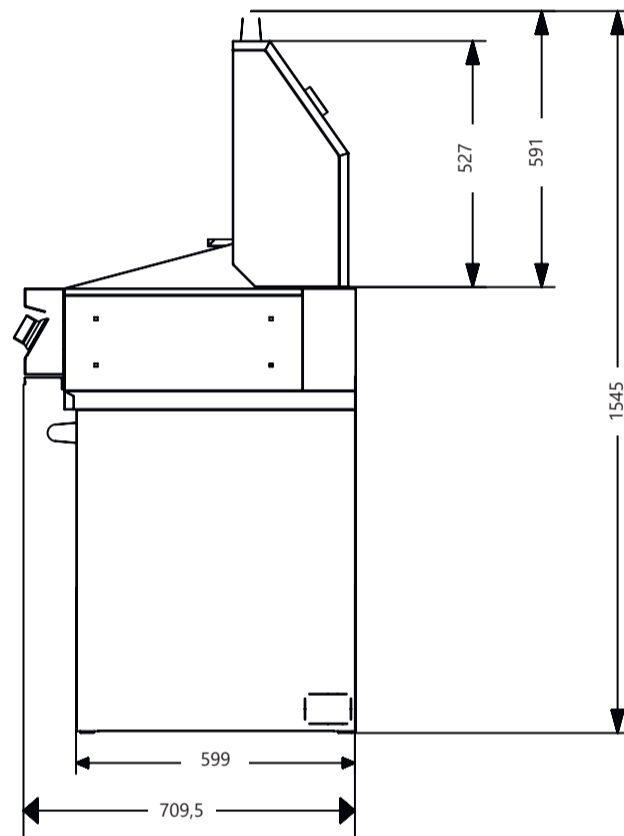
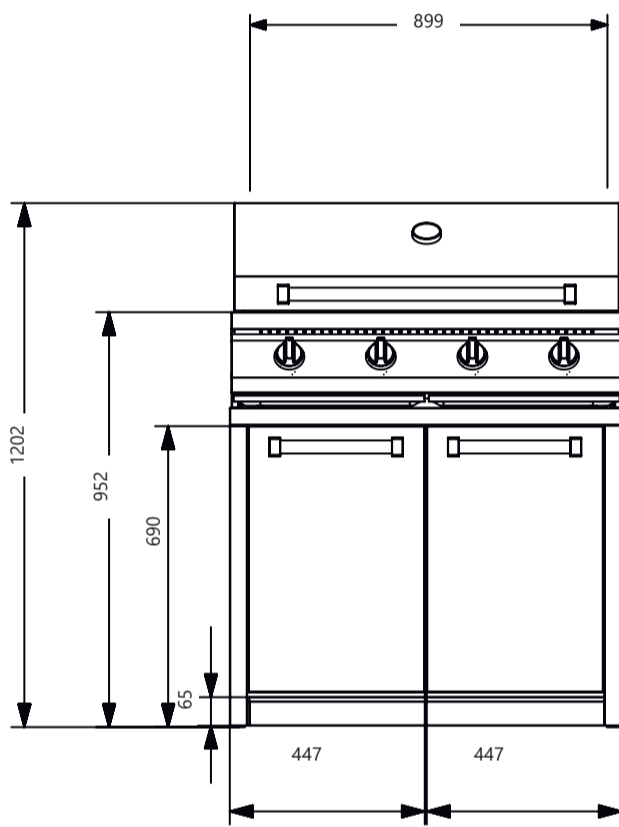

UNITS

CODE	DESCRIPTION	PRICE
G9BS-4C	Barbecue unit, L=900, with two doors; 25 kW; safety thermocouples; 3 cast iron grates, 1 double-sided plate (smooth/ridged); stainless steel flame tamers; insulated double-layer stainless steel lid with thermometer; gas cylinder compartment.	6239 €
G7BS-3C	Barbecue unit, L=700, with door; 19 kW; safety thermocouples; 2 cast iron grates, 1 double-sided plate (smooth/ridged); stainless steel flame tamers; insulated double-layer stainless steel lid with thermometer; gas cylinder compartment.	4879 €

COLOURS

CODE	COLOUR	DESCRIPTION	PRICE
	SS	Stainless steel	INCLUDED
ODC-CO AN	AN	Antracite	431 €

SWING units

Cook Unit

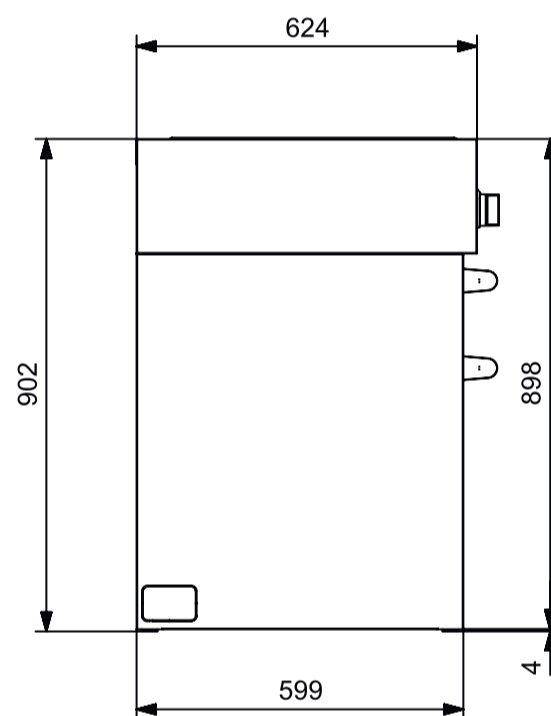
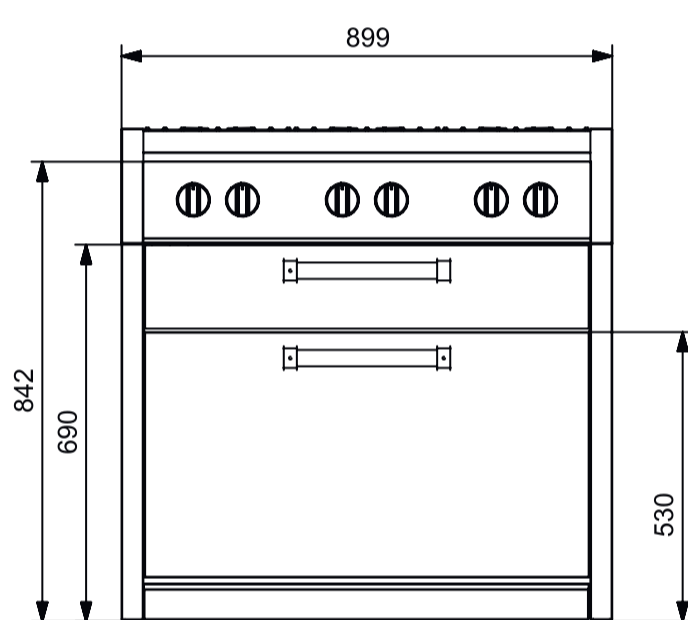

UNIT

CODE	DESCRIPTION	PRICE
G9C-6W	Stainless steel cook unit, L=900, with two soft-close drawers; 6 brass gas burners; cast iron grates; metal knobs and handles.	4738 €

COLOURS

CODE	COLOUR	DESCRIPTION	PRICE
	 SS	Stainless steel	INCLUDED
ODC-CO AN	 AN	Antracite	431 €

OPTIONAL COMPLETION ACCESSORIES

CODE	TYPE	DESCRIPTION	PRICE
SA-CG		Set of 3 stainless steel protective lids for burners.	259 €

SWING units

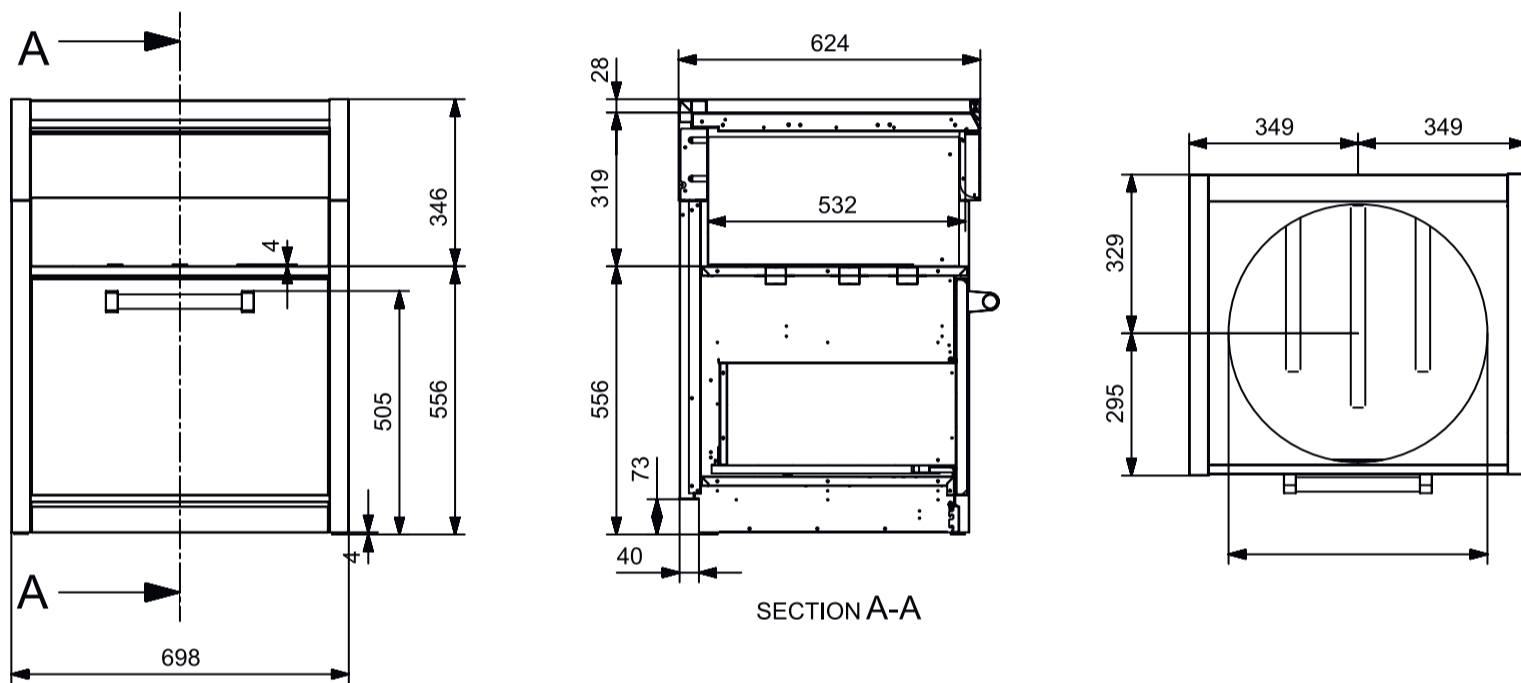

Big Green Egg Unit



UNIT

CODE	DESCRIPTION	PRICE
G7C-BGE	Stainless steel unit, L=700 mm, designed for housing a large Kamado Big Green Egg (not included); big drawer.	4311 €

COLOURS

CODE	COLOUR	DESCRIPTION	PRICE
	 SS	Stainless steel	INCLUDED
ODC-CO AN	 AN	Antracite	431 €

COMPLETION ACCESSORIES

CODE	FINISH	DESCRIPTION	PRICE	CODE	TYPE	DESCRIPTION	PRICE
SA-HPLBGE-Q		HPL cutting board kit for the Big Green Egg unit - Quercia	1006 €	GA-D7		100mm spacer*	215€
SA-HPLBGE-L		HPL cutting board kit for the Big Green Egg unit - Lavagna	1006 €				

*a 100 mm spacer is required for all units in the configuration. See accessories table on p. 59

SWINGunits

Sink Units

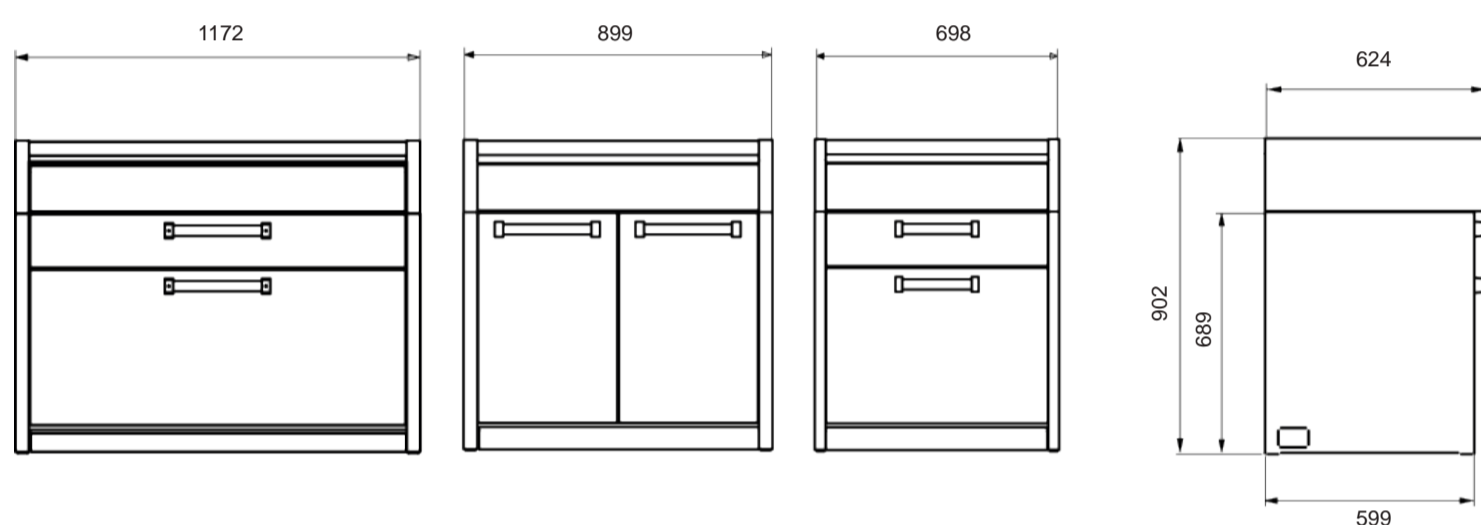

UNITS

CODE	DESCRIPTION	PRICE
G12C-L2	Stainless steel sink unit L=1200 mm with two bowls and soft-close drawers.	5226 €
G9S-L1G	Stainless steel sink unit L=900 mm with one bowl and two doors.	4371 €
G9S-L2	Stainless steel sink unit L=900 mm with two bowls and two doors.	4371 €
G7S-L2	Stainless steel sink unit L=700 mm with two bowls and one door.	4115 €

COLOURS

CODE	COLOUR	DESCRIPTION	PRICE
	SS	Stainless steel	INCLUDED
ODC-CO AN	AN	Antracite	431 €

OPTIONAL COMPLETION ACCESSORIES

CODE	TYPE	DESCRIPTION	PRICE
MPC		Professional faucet with a pull-out sprayer.	649 €

SWING units

Work Units

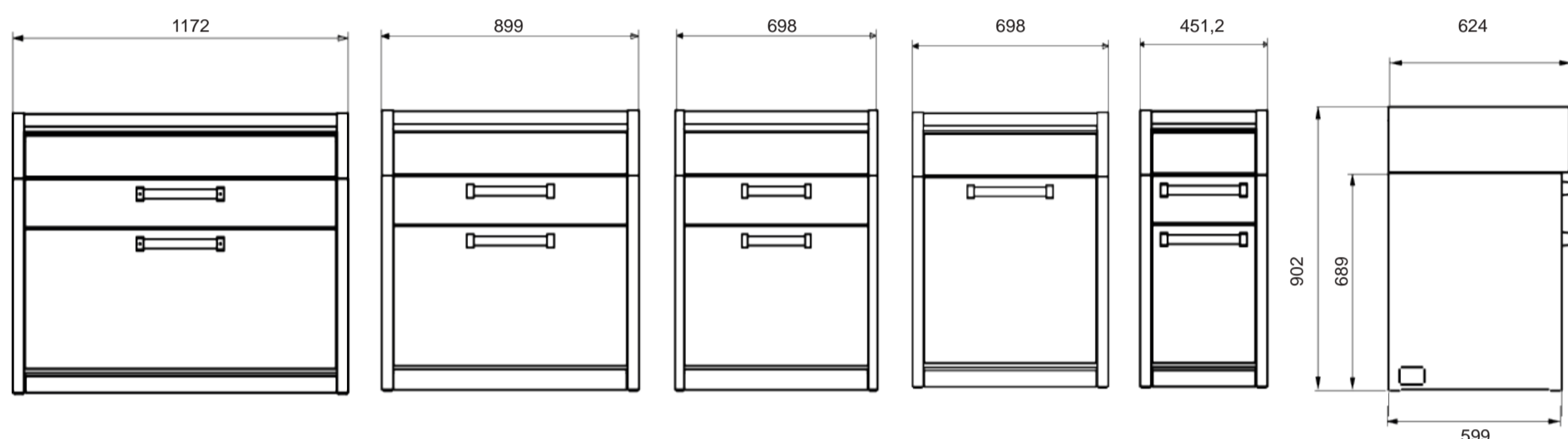

UNITS

CODE	DESCRIPTION	PRICE
G12C-P	Stainless steel work unit, L=1200 mm, with 3 drawers (one push-pull).	5226 €
G9C-P	Stainless steel work unit, L=900 mm, with 3 drawers (one push-pull).	4115 €
G7C-P	Stainless steel work unit, L=700 mm, with 3 drawers (one push-pull).	3439 €
G7S-P	Stainless steel work unit, L=700 mm, with push-pull drawer and door.	3439 €
G4C-P	Stainless steel work unit, L=450 mm, with 3 drawers (one push-pull).	2493 €

COLOURS

CODE	COLOUR	DESCRIPTION	PRICE
	SS	Stainless steel	INCLUDED
ODC-CO AN	AN	Antracite	431 €

OPTIONAL COMPLETION ACCESSORIES

CODE	FINISH	DESCRIPTION	PRICE	CODE	TYPE	DESCRIPTION	PRICE	COMPLETE UNIT CODE	TOTAL PRICE
SA-HPL12-Q		HPL cutting board for units L=1200mm - Quercia	1107 €	W4-1		Built-in quick burner; positioned on the right (R), left (L), or center (M) of the unit.	841 €	G12C-P-R	6067 €
SA-HPL9-Q		HPL cutting board for units L=900mm - Quercia	915 €					G12C-P-L	6067 €
SA-HPL7-Q		HPL cutting board for units L=700mm - Quercia	532 €					G12C-P-M	6067 €
SA-HPL4-Q		HPL cutting board for units L=450mm - Quercia	370 €					G9C-P-R	4957 €
SA-HPL12-L		HPL cutting board for units L=1200mm - Lavagna	1107 €					G9C-P-L	4957 €
SA-HPL9-L		HPL cutting board for units L=900mm - Lavagna	915 €					G9C-P-M	4957 €
SA-HPL7-L		HPL cutting board for units L=700mm - Lavagna	532 €					G7C-P-R	4280 €
SA-HPL4-L		HPL cutting board for units L=450mm - Lavagna	370 €					G7C-P-L	4280 €
									G7S-P-R
								G7S-P-L	4280 €
								G4C-P-M	3335 €

SWING units

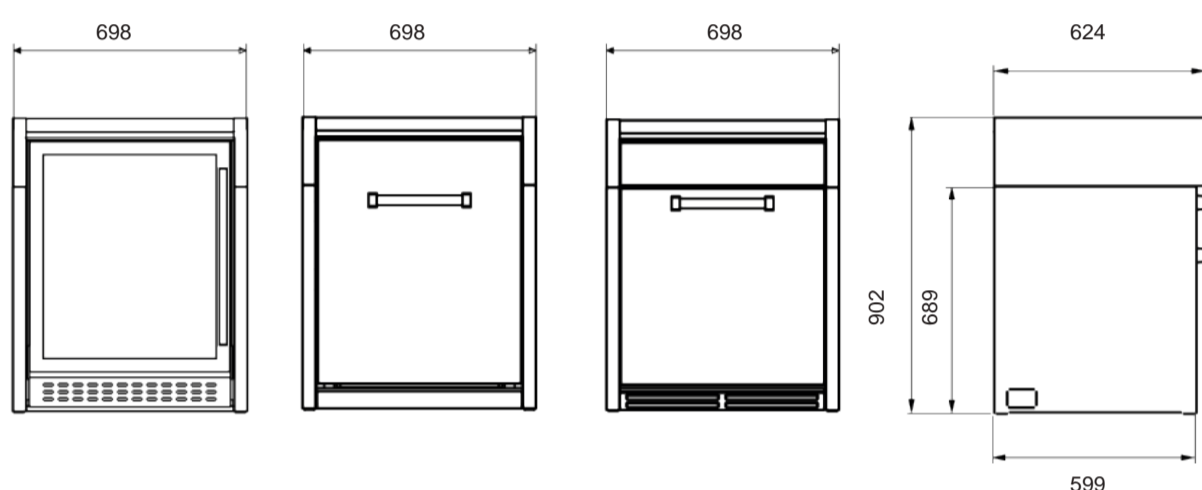

Refrigerator and Ice-Maker Units





UNITS

CODE	DESCRIPTION	PRICE
G7FR-O	Refrigerator unit with double glass door, L=700 mm; 92 L; adjustable temperature (2-10°C); body and worktop in stainless steel.	6579 €
G7FR-D	Refrigerator unit with stainless steel door, L=700 mm; 92 L; body and worktop in stainless steel.	4711 €
GPG7-P	Ice maker unit with stainless steel door, L=700 mm; 6 kg capacity; water-cooled; body and worktop in stainless steel.	5882 €



COLOURS

CODE	COLOUR	DESCRIPTION	PRICE
	 SS	Stainless steel	INCLUDED
ODC-CO AN	 AN	Antracite	431 €

OPTIONAL COMPLETION ACCESSORIES

CODE	FINISH	DESCRIPTION	PRICE
SA-HPL7-Q		HPL cutting board for units L=700mm - Quercia	532 €
SA-HPL7-L		HPL cutting board for units L=700mm - Lavagna	532 €

SWING extra accessories

TYPE	DESCRIPTION	CODE	PRICE
	Motorized rotisserie for G7BS-3C	AB-GA7	387 €
	Motorized rotisserie for G9BS-4C	AB-GA9	400 €
	Bbq tools kit	AB-KU	249 €
	S. steel Teppanyaki plate for G7BS-3C	AB-TY	700 €
	S. steel Teppanyaki plate for G9BS-4C	AB-TY3	798 €
	S. steel flame tamer for G7BS-3C, G9BS-4C	AB-DX	323 €
	Smoking tray for G7BS-3C, G9BS-4C	AB-KA	219 €
	Charcoal tray for G7BS-3C, G9BS-4C	AB-KC	323 €
	Cast iron reversible plate (smooth/ridged) for G7BS-3C, G9BS-4C	AB-PD	299 €
	Cast iron grate for G7BS-3C, G9BS-4C	AB-PA	299 €
	Stainless steel grate for G7BS-3C, G9BS-4C	AB-PX	299 €
	Pizza kit with refractory stone and paddle for G7BS-3C, G9BS-4C	AB-P7	246 €

SWING extra accessories

TYPE	DESCRIPTION	CODE	PRICE
	Care and maintenance kit	SA-KP	77 €
	Custom-made cover in nautical fabric		<i>on demand</i>
	Rear panel for BBQ unit G7BS-3C	AB-BP7	619 €
	Rear panel for BBQ unit G9BS-4C	AB-BP9	619 €
	Rear panel for units L=450mm	SA-BP4	619 €
	Rear panel for units L=700mm	SA-BP7	619 €
	Rear panel for units L=900mm	SA-BP9	619 €
	Rear panel for units L=1200mm	SA-BP12	619 €
	Front junction	GA-EG1	165 €
	Self-supporting corner unit	GMA-7	999 €
	100 mm thick spacer for BBQ unit G7BS-3C	AB-D7	215 €
	100 mm thick spacer for BBQ unit G9BS-4C	AB-D9	222 €
	100mm thick spacer for units L=450mm	GA-D4	215 €
	100mm thick spacer for units L=700mm	GA-D7	215 €
	100mm thick spacer for units L=900mm	GA-D9	222 €
	100mm thick spacer for units L=1200mm	GA-D12	239 €

SWINGbarbecues



SWING barbecues

1) Types and sizes of Swing barbecues

Swing barbecues are available in either free-standing or top (semi-built-in) version.

- Free-standing barbecues, 700 mm or 900 mm
- Barbecue top, model "grill" with insulated double-layer stainless steel lid and thermometer, 700 mm or 900 mm
- Barbecue top, 450 mm, 700 mm, or 900 mm

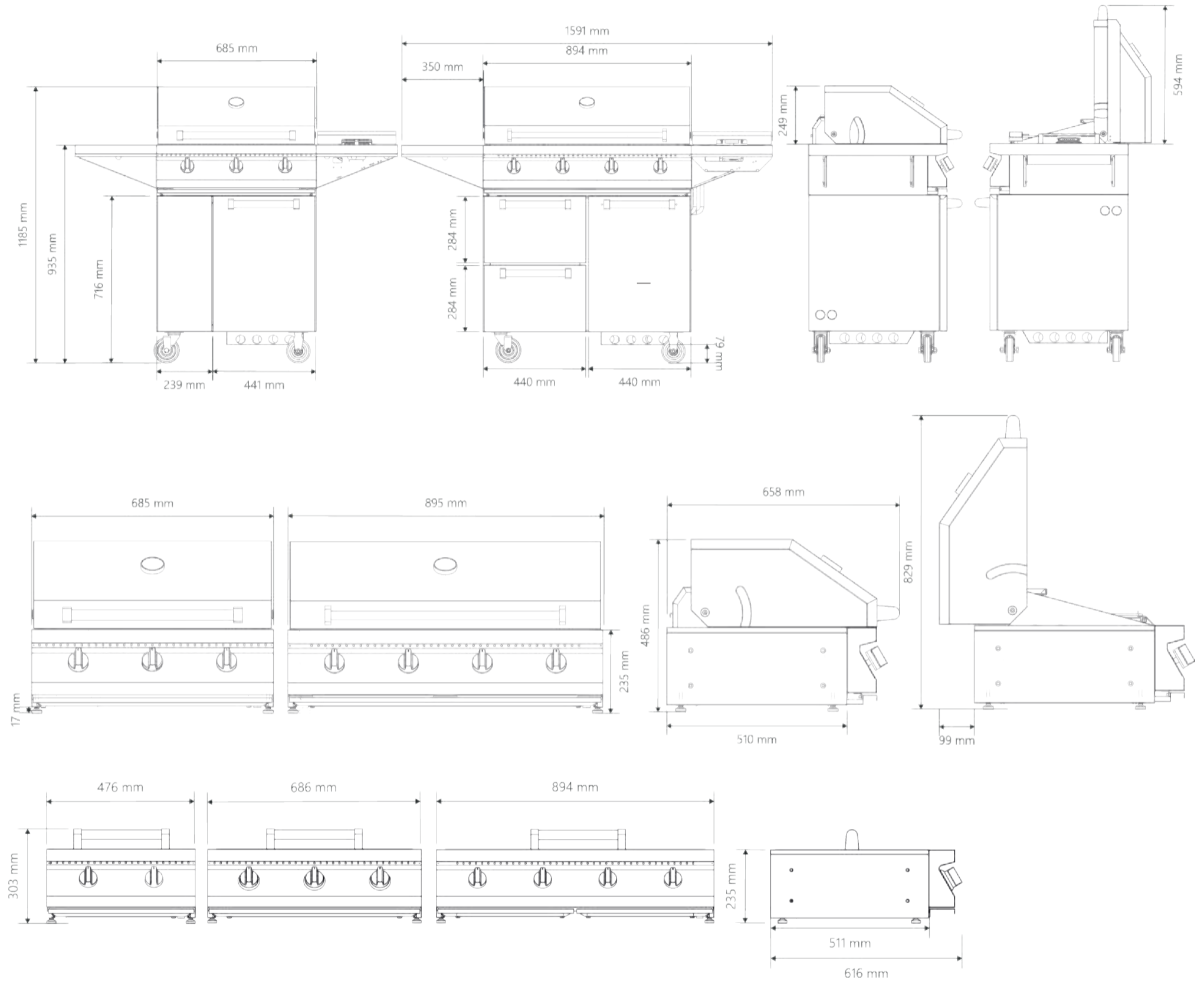

2) Features of Swing barbecues

All Swing barbecues are equipped with powerful cast steel burners, each with a capacity of 6.2 kW.

We are so confident in the quality of our burners that we offer a lifetime warranty*.

Stainless steel flame tamers ensure perfectly even grilling by distributing heat uniformly across the grates and plates.

All Swing barbecues come with one or more sturdy enameled cast iron grates and a double-sided cast iron plate (smooth/ridged).

A variety of compatible on-demand accessories make Swing barbecues extremely versatile for different cooking and grilling methods.



*Terms and conditions apply www.steel-cucine.com/it/terms-and-conditions

SWING barbecues

Free-Standing Barbecues

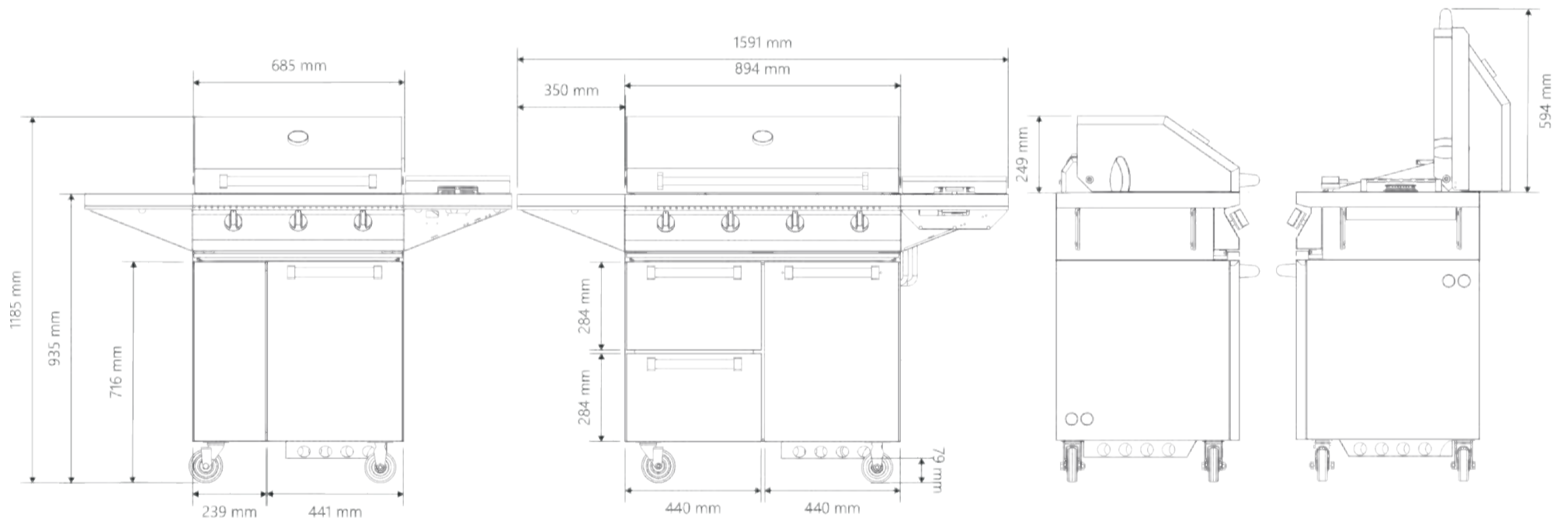

MODELS

CODE	DESCRIPTION	PRICE
W9C-4	Free-standing barbecue with a structure L=900, featuring a side shelf and a side rapid burner; 25 kW; safety thermocouples; 3 cast iron grates, 1 double-sided plate (smooth/ridged), stainless steel flame tamers, insulated double-layer stainless steel lid with thermometer; lower storage compartments.	6767 €
W7C-3	Free-standing barbecue with a structure L=700, featuring a side shelf and a side rapid burner; 19 kW; safety thermocouples; 2 cast iron grates, 1 double-sided plate (smooth/ridged), stainless steel flame tamers, insulated double-layer stainless steel lid with thermometer; lower storage compartment.	5138 €

SWING barbecues

Barbecue "Grill" Tops

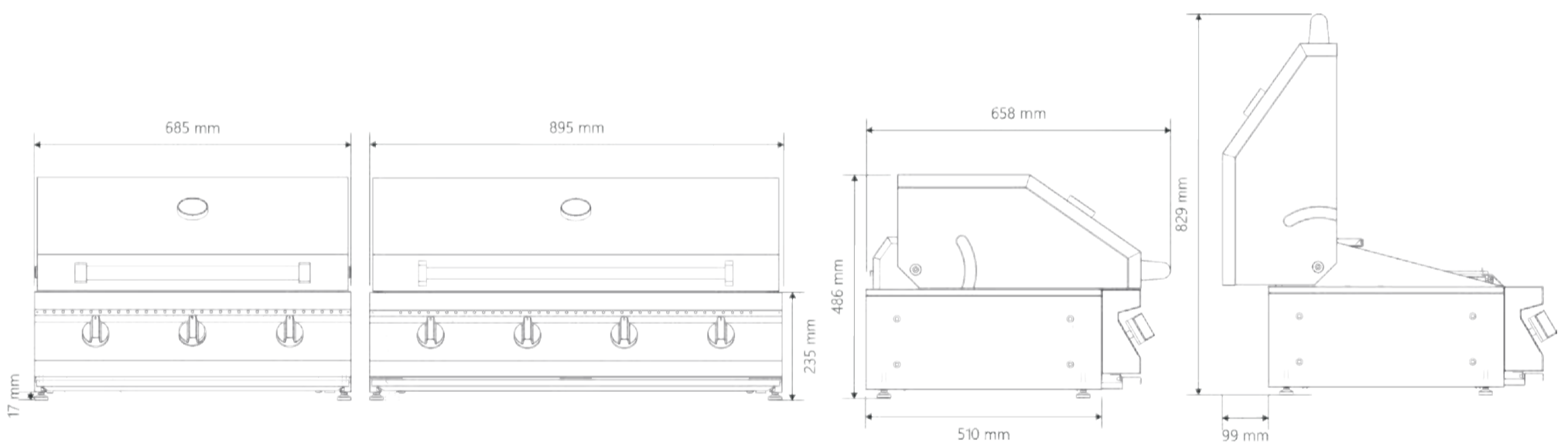

MODELS

CODE	DESCRIPTION	PRICE
W9-4G	Top barbecue for semi-built-in installation, L=900; 25 kW; safety thermocouples; 3 cast iron grates, 1 double-sided plate (smooth/ridged), stainless steel flame tamers, insulated double-layer stainless steel lid with thermometer.	5145 €
W7-3G	Top barbecue for semi-built-in installation, L=700; 19 kW; safety thermocouples; 2 cast iron grates, 1 double-sided plate (smooth/ridged), stainless steel flame tamers, insulated double-layer stainless steel lid with thermometer.	4311 €

SWING barbecues

Barbecue Tops

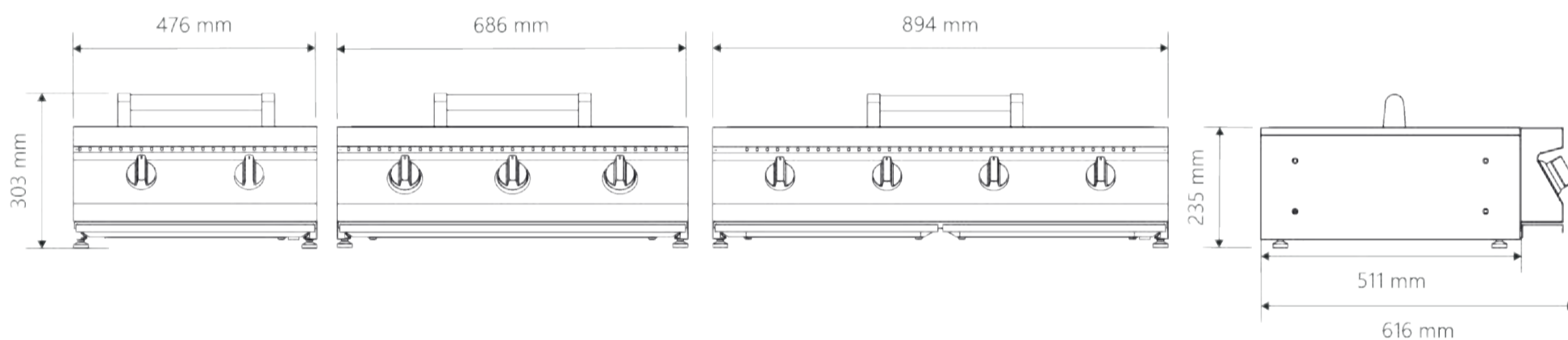

MODELS

CODE	DESCRIPTION	PRICE
W9-4	Top barbecue for semi-built-in installation, L=900; 25 kW; safety thermocouples; 3 cast iron grates, 1 double-sided plate (smooth/ridged), stainless steel flame tamers, protective lid.	3601 €
W7-3	Top barbecue for semi-built-in installation, L=700; 19 kW; safety thermocouples; 2 cast iron grates, 1 double-sided plate (smooth/ridged), stainless steel flame tamers, protective lid.	2931 €
W5-2	Top barbecue for semi-built-in installation, L=475; 12.5 kW; safety thermocouples; 1 cast iron grate, 1 double-sided plate (smooth/ridged), stainless steel flame tamers, protective lid.	1773 €

GREEN barbecues



GREEN barbecues

1) Types and sizes of Green barbecues

Green barbecues are available in either free-standing or top (semi-built-in) version:

- Free-standing barbecue, 700 mm or 900 mm
- Barbecue top, 900 mm

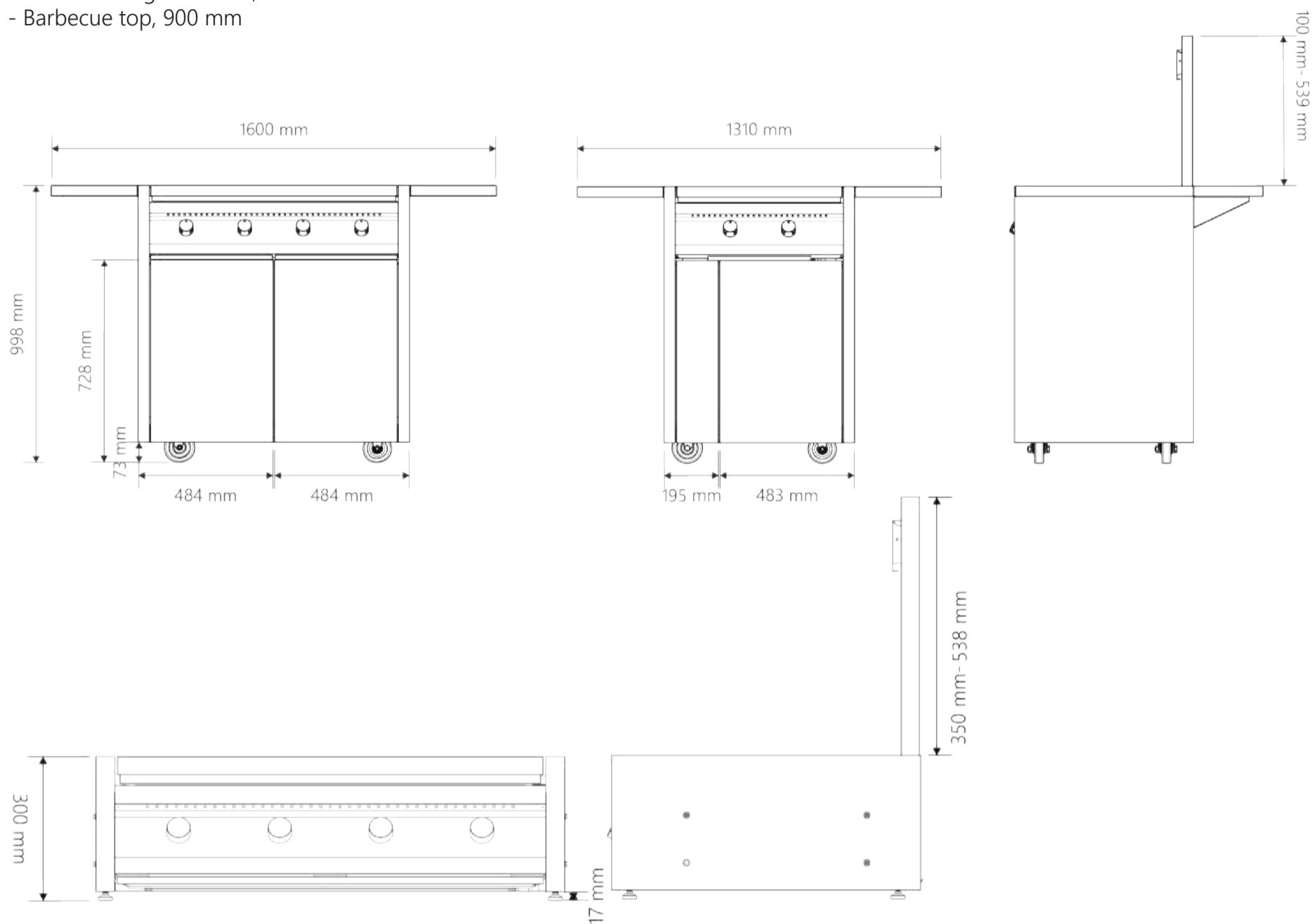

2) Features of Green barbecues

All Green barbecues are equipped with powerful cast steel burners, each delivering 6.2 kW.

We are so confident in the quality of the burners that we offer a lifetime warranty*

The ceramic flame tamers provide the taste of traditional grilling.

All Green barbecues come with one or more sturdy enameled cast iron grates, a double-sided cast iron plate (smooth/ridged), and a manual rotisserie. The telescopic steel lid that aligns with the barbecue allows for additional useful workspace. The free-standing versions feature a spacious Teak wood shelf that runs along three sides of the barbecue.



*Terms and conditions apply www.steel-cucine.com/it/terms-and-conditions

GREEN barbecues

Free-Standing Barbecues

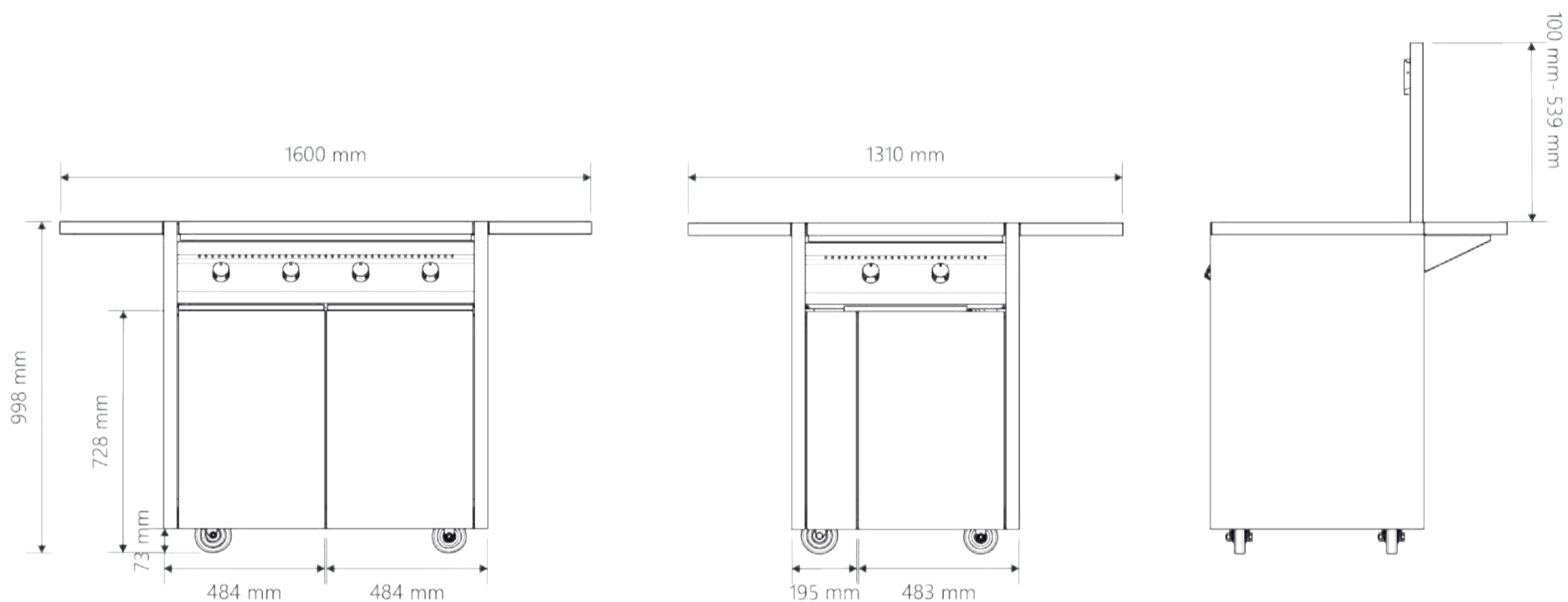

MODELS

CODE	DESCRIPTION	PRICE
I9C-4	Free-standing barbecue, L=900 with Teak wood shelf; 25 kW; safety thermocouples; 3 cast iron grates, 1 double-sided plate (smooth/ridged), 1 manual rotisserie; ceramic flame tamers, telescopic stainless steel lid; gas cylinder compartment.	8372 €
I7C-2	Free-standing barbecue, L=700 with Teak wood shelf; 12.5 kW; safety thermocouples; 1 cast iron grate, 1 double-sided plate (smooth/ridged), 1 manual rotisserie; ceramic flame tamers, telescopic stainless steel lid; gas cylinder compartment.	6814 €

GREEN barbecues



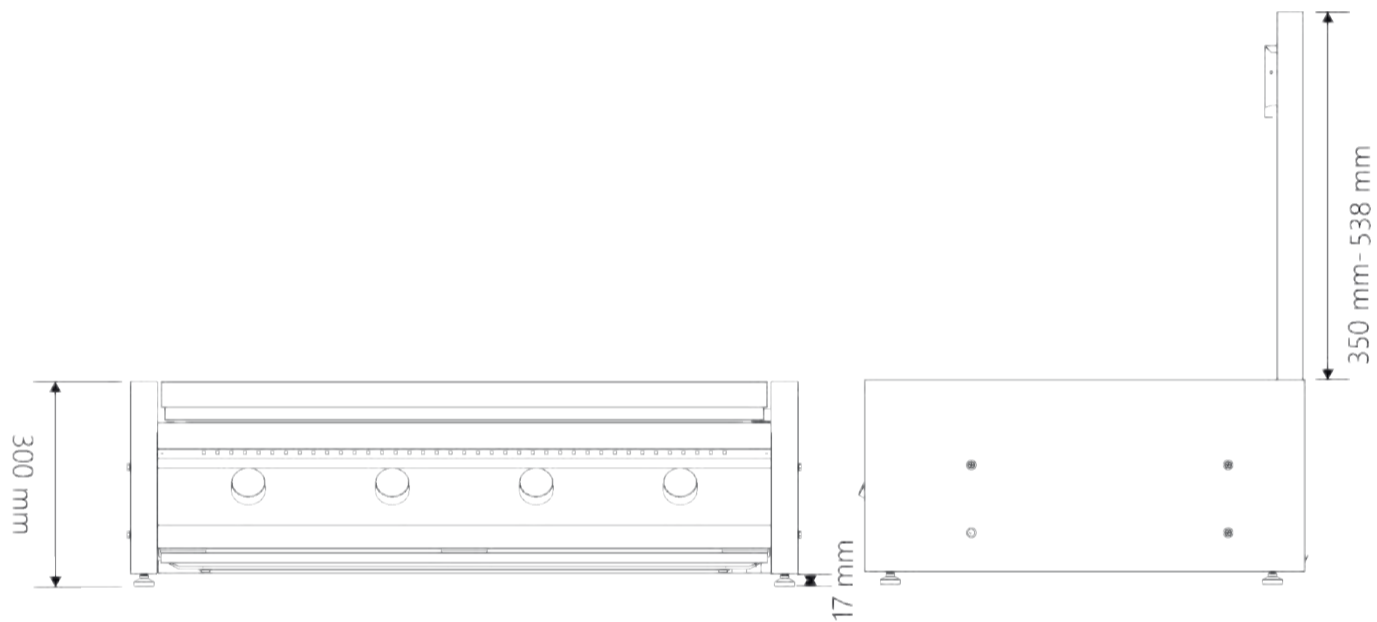









Barbecue Top

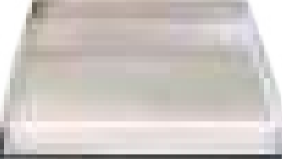
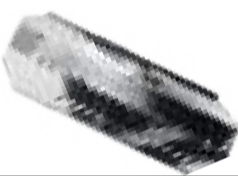
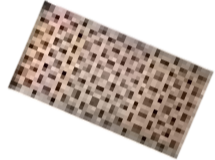

MODEL

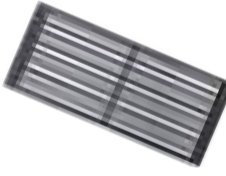
CODE	DESCRIPTION	PRICE
I9-4	Top barbecue for semi-built in installation, L=900; 25 kW; safety thermocouples; 3 cast iron grates, 1 double-sided plate (smooth/ridged), 1 manual rotisserie, ceramic flame tamers, telescopic stainless steel lid.	4587 €

BARBECUES extra accessories

TYPE	DESCRIPTION	CODE	PRICE
	Motorized rotisserie for W7-3, W7-3G, W7C-3	AB-GA7	387 €
	Motorized rotisserie for W9-4, W9-4G, W9C-4	AB-GA9	400 €
	Bbq tools kit	AB-KU	249 €
	Stainless steel Teppanyaki plate for W7-3, W7-3G, W7C-3, I7C-2	AB-TY	700 €
	Stainless steel Teppanyaki plate for W9-4, W9-4G, W9C-4, I9C-4, I9-4	AB-TY3	798 €
	Stainless steel flame tamer for Swing bbqs	AB-DX	323 €
	Ceramic flame tamer for Green bbqs	AB-PR	343 €
	Smoking tray for W9-4G, W9C-4	AB-KA	219 €
	Charcoal tray	AB-KC	323 €
	Cast-iron reversible plate (smooth/ridged)	AB-PD	299 €
	Cast iron grate	AB-PA	299 €
	Stainless steel grate	AB-PX	299 €
	Pizza kit with refractory stone and paddle for W9-4G, W9C-4, W7-3G, W7C-4	AB-P7	246 €
	PVC cover for W9C-4, I7C-2	AB-CU	246 €
	Custom-made cover in nautical fabric	-	<i>on demand</i>



STEEL SRL
Via dell'Agricoltura 21
41012 Carpi (Mo) - Italy
T. +39 059 645 180
steel@steel-cucine.com

All information provided in our communications has been prepared with the utmost care. However, Steel Srl does not guarantee the accuracy, completeness, or reliability of the information. No rights can be derived from the content, and Steel Srl shall not be held liable for any consequences arising from its use.

www.steel-cucine.com